

SQUEEZE REFRESHER

For Good Bridge Players

By

Marvin L. French

CONTENTS

INTRODUCTION	1
NOMENCLATURE	2
Threat Types	2
Additional Definitions	3
Notes	3
RULES FOR ALL SQUEEZES	4
Declarer:	4
Defenders:	4
SIMPLE SQUEEZES	5
Sinister Squeeze	5
Ambidextrous Squeeze	6
Splitter Squeeze	7
Back-Door Squeeze	8
Criss-Cross Squeeze	9
Defender's Winner Squeezes Partner	9
Defenders Squeeze Declarer	9
Declarer Squeezes Self	9
TRUMP SQUEEZES	10
Trump	10
Scissors	12
TWO-SUIT STRIP SQUEEZES	14
Strip and Endplay	14
The Steppingstone	16
Strip and Establish	17
Strip and Duck	17
Topless Strip	19
The Vise	22
The Winkle	26
THREE-SUIT STRIP SQUEEZES	27
Three-Suit Strip and Endplay	27
Three-Suit Strip and Establish	28

DOUBLE SQUEEZES	33
Type R Double Squeeze	33
Type L Double Squeeze?	35
Type B1 Double Squeeze	36
Unrestricted	36
Restricted	38
Type B2 Double Squeeze	41
Simultaneous B2 -	41
Non-Simultaneous B2 -	42
Simple Squeeze Played as a Double Squeeze	44
 GUARD SQUEEZES	 45
Type R Double Guard Squeeze	45
Type L Double Guard Squeeze	47
 TRIPLE SQUEEZES	 50
North has one threat, South two	50
North has two threats, South one	53
North has all three threats	55
 COMPOUND SQUEEZES	 57
Type R Compound Squeeze	57
Unrestricted	57
Restricted	62
Type L Compound Squeeze	67
Unrestricted	67
Restricted	68
Alternative Threat Compound Squeeze	74
 KNOCKOUT SQUEEZES	 78
 BACKWASH SQUEEZES	 81
 ENTRY SQUEEZES	 84
 ENTRY-SHIFTING SQUEEZES	 86
Trump Entry-Shifting Squeezes	86
Balanced Trump Holding	86
Unbalanced Trump Holding	88
Notrump Entry-Shifting Squeezes	91

INTRODUCTION

This book is a summary of the squeeze positions that every good bridge player should know, and the requirements for their execution. Extremely rare squeezes are not included. Well, maybe a few.

Clash squeezes are not included. For those interested, a thorough treatment can be found on *The Bridge World's* website www.bridgeworld.com It has a fine article on clash squeezes by Xiaobo Zhang in its Esoterica section.

Saturated squeezes are not included either. An article by Don Kersey on this subject appeared in *The Bridge World*, August 2003.

The purpose of the book is not to teach novices about squeezes, but to serve as a review for those who are already acquainted with the subject.

Some new nomenclature is included, based on a perceived need.

Many thanks to Alvin Bluthman, Tim West-Meads, and especially to the eagle-eyed Danny Kleinman.

NOMENCLATURE

The definitions for various terms used in this document are presented here in a logical, rather than alphabetical, order.

Squeeze: A play that forces a discard that will cost a trick, sooner or later

Squeeze card: A card that squeezes a hand when it is played

Squeezee: A hand that is squeezed

Squeezer: The hand containing the squeeze card

Threat: A loser that the defender(s) must guard from becoming a winner.

Guard: Opponent's card that prevents a threat from becoming a winner

Weak guard: An "endplayable" defensive guard, with the opposing threat protector constituting a major tenace (e.g., defender's Kx when declarer holds AQ).

Protector: A winning card that protects a threat in that suit

Establish: Turn a non-winning card into a winner

Entry: A high card that is conveniently accessible from the opposite hand.

LHO: Left-hand opponent

RHO: Right-hand opponent

Threat Types

Naked threat: An unprotected threat

Split threat: A threat with protector(s) only in the opposite hand

Single threat: A threat guarded by one opponent only

Double threat: A threat guarded by both opponents, "B threat" for short

Basic threat: The single threat required for a guard squeeze or compound squeeze

Finesse threat: A finesse can be made only if the opposite hand becomes void in the suit.

Lonely threat: A threat in a hand containing no other threat

L threat: A threat guarded only by LHO of a lonely threat

R threat: A threat guarded only by RHO of a lonely threat

B1 threat: A singly-protected double threat (i.e., one winner)

B2 threat: A doubly-protected double threat (i.e., two winners)

Extended threat: Two or more threats in one suit (e.g., AJ9 vs opposing KQ10. Both the jack and 9 are threats, since if the jack is established the 9 becomes a winner also)

Companion-Lead-Access (CLA) threat (required for a Strip and Establish squeeze):

A threat companioned ("C") by one or more other losers in the suit, and

— Hand with squeeze card must have a card in CLA suit to lead ("L"), and

— established threat(s) must be accessible ("A") for cashing.

— A CLA threat may be extended

Additional Definitions

Lth Hand: The opposing hand that guards an L threat

Rth Hand: The opposing hand that guards an R threat

L suit: The suit containing an L threat

R suit: The suit containing an R threat

F suit: A suit with winners but no significant threat (“free suit,” “free winners”).

Fork: Decision time for alternative lines of play

Vienna Coup: Early cashing of split-threat protectors for the purpose of unblocking. The threat is changed from a protected threat to a naked threat.

Notes

The compass directions North, South, East, and West will often be used with the following conventional understanding: South is the hand with the last F winner, usually the squeeze card. South is often referred to as “declarer.”

Defenders can execute a squeeze as well as declarer, so the words “declarer” and “defender(s)” are used with the understanding that the roles could be reversed.

Situations are shown with high cards only for clarity. Most of the hand diagrams would be impossible positions in actual play, but using KJ (for instance) instead of 75 makes for easier comprehension.

RULES FOR ALL SQUEEZES

Declarer:

- Correct (“rectify”) the required loser count as early as possible, often at trick one.
- Don't overlook a dummy reversal, which may be a superior line of play.
- Remember to perform Vienna Coup when necessary.
- Cash all winners not needed for the squeeze position as early as possible

One of the common errors made by inexperienced players is to cash all of dummy's high cards before playing off the high cards in their hand. This usually insures that there will be no squeeze.

Defenders:

- Eliminate threats when possible, often by repeatedly leading a suit until declarer and dummy have no more cards in the suit
- Do not rectify the count for declarer by cashing winners before you have to.
- Both defenders should guard a threat as long as possible, to avoid turning a double threat into a more valuable single threat.
- When having to unguard a threat, generally unguard one that is on your left if partner can guard it. When defenders are sitting over (to the left of) all threats, there can usually be no squeeze.
- Attack threat protectors, especially double-threat protectors.
- Disrupt communications (e.g., cause one opposing hand to be void in a suit)
- Do not signal partner that you have control of a suit if you may be squeezed out of that control.
- When you see that you are going to be squeezed or endplayed, make the trick-costing discard early (e.g., blank a king). Don't wait until the squeeze trick.
- When hoping to break up an impending double squeeze and declarer has two threat suits with a winner in each hand (i.e., Axx opposite Kxx), attack the suit thought to be 3-3 rather than one that is likely to be 3-2.

SIMPLE SQUEEZES

The requirements for simple squeezes, mostly necessary but not always sufficient, are:

- One loser in hand: "All the tricks but one"
- Two threats against one opponent
- At least one threat has a protector (winning card)
- At least one threat is "over" (on the left of) the squeezee
- Any threat unguarded by the squeezee can be reached for cashing

There are five basic types of simple squeeze:

- (1) Sinister Squeeze
- (2) Ambidextrous Squeeze
- (3) Splitter Squeeze
- (4) Criss-Cross Squeeze
- (5) Back-Door Squeeze

In all these squeezes, the last winner in the F suit (free suit) is the squeeze card.

Sinister Squeeze

- Both threats lie on the left of (over) the squeezee.
- The last F-suit winner (the squeeze card) lies opposite the threats.
- At least one threat is protected (only one preferably, the other "naked").
- Only the hand on the left of the squeeze card can be squeezed.

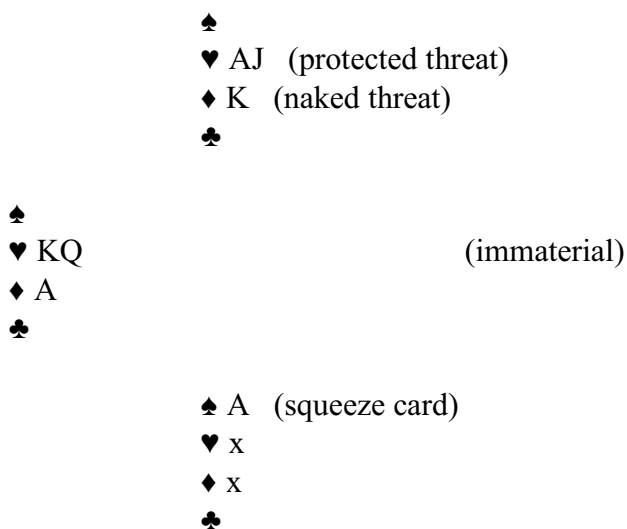

When the ace of spades is cashed, West must unguard one of North's threats. Holding West's cards, East could merely discard from the same suit played by the North hand, so there would be no squeeze. The small heart in the South hand provides the means for reaching the threat unguarded by West. If it were not there, West could discard a heart with impunity.

In many squeeze situations, a double threat (guarded by both opponents) may have to be turned into a single threat (guarded by only one opponent) by ruffing out or otherwise eliminating one defender's guard. Also, a single-threat guard may have to be transferred from the opponent who is "over" the threat to the one who is "under":

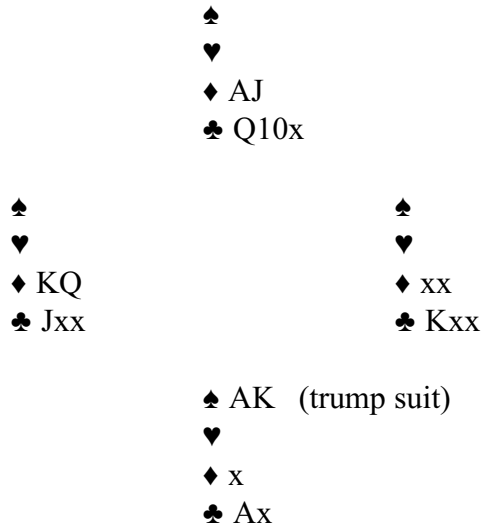

The club queen is led, covered by East, captured by South. This transfers the club guard from East to West, producing the conditions required to squeeze West. (Perhaps East previously made an "odd-even" discard signaling club strength, a wonderful defensive play convention designed to help declarers make overtricks). A more common method of "isolating the threat" is to ruff out the guard(s) held by one defender, so that only the other can guard the threat.

Ambidextrous Squeeze

- One hand holds a protected threat.
- A second threat lies in the hand opposite, with the squeeze card.
- Either opponent can be squeezed.

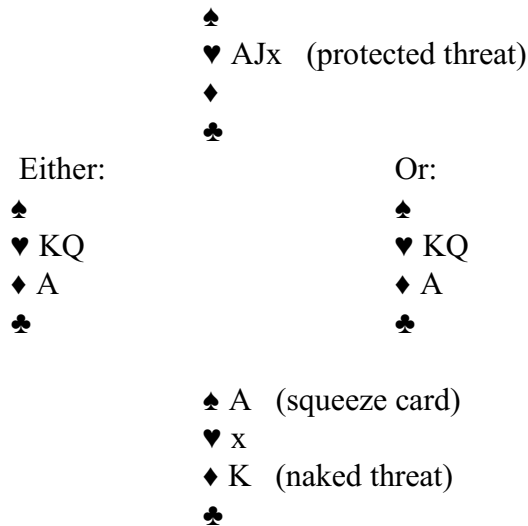

Declarer doesn't care which opponent, left or right, guards the threats. If the ace of diamonds does not appear on the squeeze trick, the only hope is that someone has been squeezed and the jack of hearts will take the last trick.

Splitter Squeeze

- One hand holds a (preferably) naked threat.
- That hand holds the protector half of a split threat, with a small card
- The other hand holds the threat itself, with a small card in that suit, along with the squeeze card.

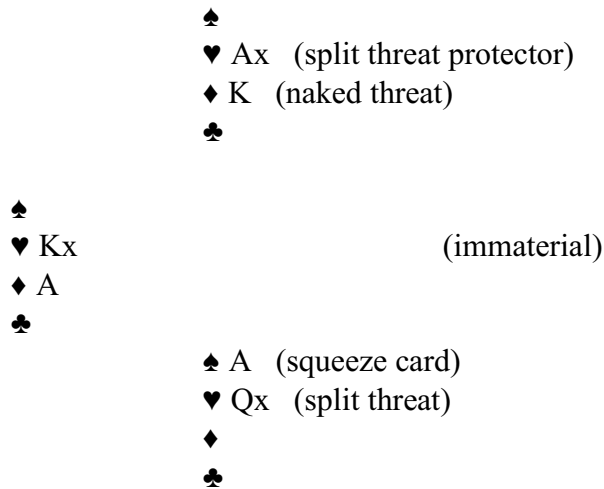

When the squeeze card is played, West will probably discard a heart. Declarer throws the now-useless diamond king, and picks up the now-singleton heart king. The small heart in the North hand is needed for access back to South's queen.

In all these squeezes, especially this one, if threats shown as naked threats are actually protected threats, the protector is unnecessary and should be cashed early if possible. Otherwise there may be doubt as to which suit the squeezee has unguarded, a situation known as "ambiguity." Usually ambiguity can be resolved after the squeeze card is played, but sometimes not. It is therefore wise to cash unneeded winners as early as possible.

Back-Door Squeeze

- One hand holds a (preferably) naked threat.
- The other hand holds the squeeze card and a threat that has two or more protectors, one of which lies in the hand with the naked threat.
- Either opponent can be squeezed.

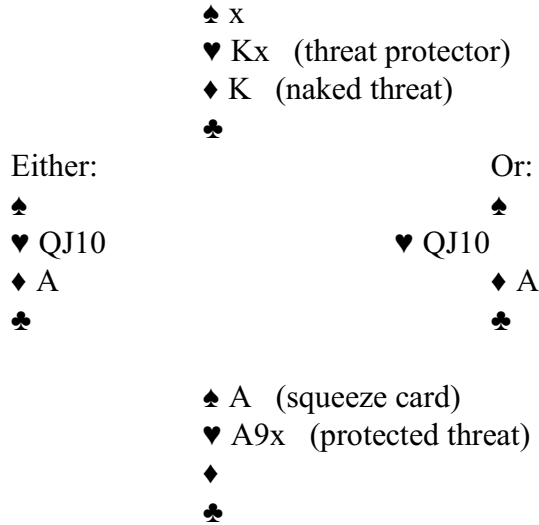

After the squeeze is complete, the squeezee typically holding on to the naked-threat guard, declarer goes “around the horn,” over to the opposite hand, returning via the back door (his hand) to cash the now-established threat.

If the spade ace had been in the North hand, this would be a simpler Ambidextrous Squeeze. The extra protector in the North hand is what permits either opponent to be squeezed, and allows the squeeze card to lie opposite the naked threat. Without it, only East could be squeezed, and the squeeze card would have to lie in the North hand (Sinister Squeeze).

Criss-Cross Squeeze

- Each hand has a split threat (threat with protector in the opposite hand).
- The squeeze card can lie in either hand.
- Either opponent can be squeezed.

	♠ x	
	♥ A (threat protector)	
	♦ Qx (split threat)	
	♣	
Either:		Or:
♠		♠
♥ Kx		♥ Kx
♦ Kx		♦ Kx
♣		♣
	♠ A (squeeze card, could be North's)	
	♥ Qx (split threat)	
	♦ A (threat protector)	
	♣	

Declarer cashes the ace of the suit that is unguarded by the opponent, making the other hand high. The situation may be ambiguous, as declarer must figure out which ace to cash first.

Defender: Blank one of the guards early, not waiting for the squeeze card. Declarer will probably go wrong, thinking the final discard blanked a guard.

Defender's Winner Squeezes Partner

In many of these positions, don't overlook the possibility that the squeeze card can be a defender's winning card. Typically, the next-to-last loser is conceded, simultaneously squeezing the partner of the defender who wins the trick. Another possibility is that a defender is thrown in when there are more than two losers, and the defender (often unnecessarily) cashes enough winners to squeeze partner ("Fratricidal Squeeze", called "Suicide Squeeze" by some).

Defenders Squeeze Declarer

While the more advanced squeezes are rarely executed by defenders, the simple squeezes come up once in a while. Defenders must keep in mind the possible need to rectify the count of losers for a squeeze. That's a lot to ask of a player who can't see partner's hand.

Declarer Squeezes Self

It often happens that declarer cashes too many high cards from one hand, with the result that there is no safe discard from the hand opposite, perhaps after a defender cashes one or more winners. ("Suicide Squeeze," called "Cannibal Squeeze" by some).

TRUMP SQUEEZES

Trump Squeeze with Unbalanced Trumps

In a trump squeeze, the ability to ruff plays a part in the squeeze. The typical trump squeeze has these requirements:

- One loser (all the tricks but one), with exceptions
- Two threats, one in a hand with longer trumps, one opposite
- Establishment of the opposite hand's threat requires a ruff of that suit after the squeeze is complete.
- Threat in long trump hand has protector(s) in opposite hand (split threat).
- The hand opposite the long trump hand has two entries.

Here the two entries required for one ruff and return to North's hand are protectors in South's threat suit. Either opponent (sometimes both!) can be squeezed:

	♠	
	♥ KJ (threat)	
	♦	
	♣ AKx	
Either:		Or:
♠		♠
♥ AQ		♥ AQ
♦		♦
♣ QJx		♣ Qjx
	♠ AK (trumps; first is squeeze card)	
	♥	
	♦	
	♣ 10xx (split threat)	

The squeeze occurs when the next-to-last F winner (a trump, in this case) is cashed, and an idle card (a club in this case) is discarded from the opposite hand. If the squeezee discards a heart, South can ruff out the heart ace and the North hand is high. If a club is discarded, South cashes the high clubs and returns to the established club 10 via a ruff.

The squeeze works even when both defenders control clubs, if they both must guard against a heart ruff (e.g., Qx of hearts in the West hand and Ax in the East hand).

The second entry (other than the required protector in South's threat suit) can be any of the following:

(1) As above, a second entry in South's threat suit

(2) Next-to-last trump (squeeze card) is won in North's hand:

	♠ A (squeeze card)	
	♥ KJ	
	♦	
	♣ A	
Either:		Or:
♠		♠
♥ AQ		♥ AQ
♦		♦
♣ KQ		♣ KQ
	♠ xx (trumps, a higher trump outstanding)	
	♥	
	♦	
	♣ Jx	

When the ace of spades is cashed, either opponent can be squeezed.

(3) A side-suit winner (and squeeze card) in North's hand. The South hand has one trump, for ruffing.

	♠	
	♥ KJ	
	♦ A (squeeze card)	
	♣ A	
Either:		Or:
♠		♠
♥ AQ		♥ AQ
♦		♦
♣ KQ		♣ KQ
	♠ A (trump, used for ruffing)	
	♥	
	♦ x	
	♣ Jx	

When the ace of diamonds is cashed, either opponent can be squeezed.

(4) A protector-entry in the ruffing threat suit:

	♠	
	♥ A10xx	
	♦	
	♣ A	
Either:		Or:
♠		♠
♥ KQJ		♥ KQJ
♦		♦
♣ KQ		♣ KQ
	♠ AK (trumps; first is squeeze card)	
	♥ x	
	♦	
	♣ Jx	

When a trump is cashed, either opponent can be squeezed.

Ambiguity is frequently encountered in trump squeezes: Which suit has been unguarded? If a simple squeeze can be arranged instead, go for the simple.

Look for a trump squeeze when threats are not located correctly for another type of squeeze.

Since the ruffing hand must have more trumps than the other hand, it may be necessary to do some preliminary ruffing in order to achieve the necessary trump distribution.

Defender: Blank the non-ruffable guard early, not waiting for the squeeze card, unless that leaves declarer with no hope of ruffing out the guard in the ruffing threat suit. If declarer cannot be sure of ruffing out a winner, you can unguard the ruffing-threat suit early (pretending to have extra length there), and make the last discard (safely) from the other threat suit. Partner must cooperate in either of these strategies, avoiding discards in the suit from which you discard.

Scissors Squeeze

This is a sort of criss-cross trump squeeze.

Requirements:

- Trump length must be equal in each hand
- Each hand has an extended threat accompanied by an entry-protector
- Either opponent can be squeezed.

	♠ x	
	♥ A10x	
	♦ x	
	♣ x	
Either:		Or:
♠		♠
♥ KQJ		♥ KQJ
♦		♦
♣ KQJ		♣ KQJ
	♠ AK (trumps)	
	♥ x	
	♦	
	♣ A10x	

The lead is in the North hand, and the diamond is not high. The diamond must be ruffed immediately, balancing the trumps and squeezing either opponent on that trick. If instead both spades are cashed, there is no squeeze.

More advanced trump squeezes, often combined with other types of squeeze to form a hybrid squeeze, are beyond the scope of this book.

TWO-SUIT STRIP SQUEEZES

In strip squeezes, declarer surrenders the lead after playing the squeeze card, forcing an opponent to give up a trick in a suit he must lead, or lead to a winner declarer can't reach, or perhaps just establishing a trick in the suit led. Prior to this surrender of lead, the opponent's hand has been squeezed out ("stripped") of any cards that would foil declarer's purpose.

When a simple squeeze is not available because there is no way to rectify the count (to one loser), or the threats are misplaced, or whatever, a two-suit strip squeeze may be in order if the squeezee has a weak (endplayable) guard or one threat is a CLA threat.

The two-suit strip squeeze is often preferable to a simple squeeze for another reason: When a simple squeeze would be possible by conceding a trick in order to rectify the count to one loser, the two-loser feature of the strip squeeze permits declarer to make an extra trick occasionally. If an unlikely trick comes from elsewhere (e.g. a queen drops, or a suit splits 3-3), the count becomes rectified for a simple squeeze. Ducking to one loser earlier would have given up a trick unnecessarily.

A bad feature is the ambiguity that sometimes arises. For this reason a simple squeeze may be preferable when given a choice. Simple squeezes seldom have ambiguity problems.

Strip and Endplay

This squeeze requires:

- Two threats against one opponent.
- At least one threat is against a weak guard (i.e., declarer has a major tenace in that suit, such as AQ with an opponent holding the king)
- An entry to established threat(s) or, if none established:
- An entry to squeezee's hand for the endplay
- Just two losers remaining, unless the squeezee has no exit card to partner's hand

An extended threat may satisfy the two-threat requirement.

The two-suit Strip and Endplay is guaranteed to gain a trick with just two losers remaining, but will work with more losers if the squeezee has no side-suit exit card. He will be squeezed out (stripped) of any "excess" winners in side suits, no matter how many losers declarer has, and so must have an exit card (i.e., a loser) in order to escape the endplay. With two losers, the defender will be stripped of any such "out-card." It is therefore a good idea to rectify the count by ducking down to two losers if that is possible.

An attractive feature of this squeeze is that it will work against either opponent, no matter who guards the threats.

♠ Q543
 ♥ 873
 ♦ KQ7
 ♣ Q32

♠ J92
 ♥ 2
 ♦ 10432
 ♣ J87654

♠
 ♥ KQJ964
 ♦ 9865
 ♣ K102 (weak guard)

♠ AK10876
 ♥ A105
 ♦ AJ
 ♣ A9

South	West	North	East
1♠	Pass	3♠	4♥
6♠	Pass	Pass	Pass

The heart two is led and South must take the ace. In a 6NT contract declarer could have ducked the heart lead to set the stage for a type 3 (Splitter) simple squeeze in hearts and clubs (run spades, then diamonds). In six spades the duck is unavailable, but no matter; the two-suit strip squeeze works with two losers. South cashes all spade and diamond winners, coming down to three cards (stripping East of the fourth diamond), then throws East in with a heart to force a lead from the club king. East's best defense is to throw the club ten and club two early, keeping that fourth diamond and making South guess who has it.

In some cases the order of cashing winners is important. The following deal was misanalyzed in a well-known bridge column:

♠ K109x
 ♥ AKx
 ♦ AQJ
 ♣ KJx

♠
 ♥ J109xx
 ♦ xxxx
 ♣ Qxxx

♠ QJxx
 ♥ xx
 ♦ 5432
 ♣ xxx

♠ A8xxx
 ♥ Qxx
 ♦ Kx
 ♣ Axx

Playing 6NT in a matchpoint game, South gets a heart lead. Declarer could play safe for the contract by making a safety play in spades, which involves finessing on the first round. If that loses, there are no more losers. However, this is matchpoints, so declarer wants to take all the tricks. Guessing wrong, declarer plays the ace of spades first. At this point, the columnists said, defeat is certain.

Defeat may be likely, but not certain. Declarer finesses in clubs, cashes the club and heart winners, then the diamond winners. Having been stripped of the fourth diamond when the hearts were cashed, East is down to QJx of spades, and South ducks a spade into that hand for an endplay.

Note that if declarer cashes the diamond winners first, East can hold on to the fourth diamond and defeat the contract. Would that be an exception to the statement that this squeeze will always work with two losers? No, because there is no weak guard until a spade is ducked into QJx. If East had been able to hold onto a diamond and the QJ of spades, there is no weak guard before the duck and the prerequisites for the Strip and Endplay have not been met.

Playing hearts and clubs first is not double-dummy, since East is more likely to be long in diamonds than in those two suits.

As in this deal, an extended threat can sometimes satisfy the usual two-threat requirement.

Rule: When cashing side-suit winners, cash your longest suit(s) first.

Defenders: Don't discard an apparently worthless card (e.g., a diamond on the third heart in the above deal) that could become a winner in a strip squeeze ending.

The Steppingstone

The Steppingstone strip squeeze is based on the same principles as the Strip and Endplay, but instead of leading into a major tenace, the squeeze, after being stripped of an out-card or excess winners, is forced to lead to a winner that declarer cannot reach. It can save the day in many sorts of blocked position.

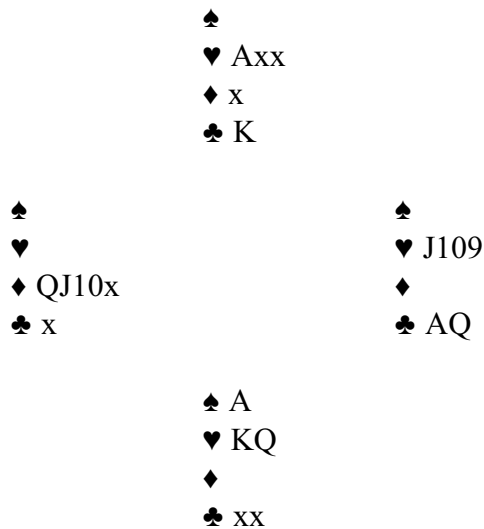

South has four tricks, but the hearts are blocked. The ace of spades (diamond from North) strips the queen of clubs from East's hand. Now South cashes the king-queen of hearts and plays a club to East's ace, a steppingstone to the heart trick in the North hand.

	♠	
	♥	
	♦ KQ10x	
	♣ A	
♠		♠
♥ J10		♥ KQ
♦		♦ AJ9
♣		♣
	♠ A (squeeze card)	
	♥ Ax	
	♦ xx	
	♣	

Declarer has four tricks in a notrump contract, but also has a communication problem. If East were to take the diamond ace on the first round, there would be no problem. But if the diamond is ducked? However, the spade ace, diamond discard from North, squeezes East:

If East discards a heart, declarer can safely cash the heart ace (throwing the other low diamond from the North hand) before leading a diamond and taking four tricks.

If East throws a diamond instead of a heart, the heart ace is kept as a stopper and a diamond led. If East takes the diamond, dummy is good. If East ducks, playing the jack, declarer cashes the ace of clubs and leads a diamond to East's ace, using it as a steppingstone to South's heart ace. The heart winner is necessary *after* the squeeze, of course, and must not be cashed before the squeeze card is played.

Strip and Establish

The requirements for these squeezes, not always sufficient, are:

- Just two losers remaining, unless the squeeze has no exit card
- Two threats against one opponent, consisting of:
 - A protected threat, and
 - A CLA (Companion-Lead-Access) threat that may or may not include a protector-entry.

Characteristics of a CLA threat:

- A threat companioned by one or more other losers in the suit ("C"), and
- Hand with squeeze card must have a card in CLA suit to lead ("L"), and
- Established threat(s) must be accessible ("A") for cashing.

There are two basic variations of the Strip and Establish, depending on whether the CLA threat includes a protector-entry. These are the Strip and Duck and the Topless Strip:

Strip and Duck

This variation always works with two losers, even in a notrump contract. It will often work with more if the squeeze has no exit card.

There are two possibilities: (1) Both threats lie over the squeeze card opposite, and only one hand can be squeezed; or (2) the threats are not in the same hand, the squeeze card can lie in either hand, and either opponent can be squeezed.

Here is a layout illustrating possibility (1):

	♠ x	
	♥ A10x (CLA threat)	
	♦ AJ (protected threat)	
	♣	
	:	
♠		
♥ KQJ		(immaterial)
♦ KQ		
♣ x		
	♠ AK (F suit)	
	♥ xx	
	♦ xx	
	♣	

Declarer has two losers in a notrump contract. The heart ace is necessary to prevent West from keeping the club. On the first spade West throws a heart. On the last spade West cannot throw another heart and must discard the club. Then a heart is safely ducked.

(2) Threats are not in the same hand, and either opponent can be squeezed::

	♠ x	
	♥ A10x (CLA threat)	
	♦ x	
	♣	
Either:		Or:
♠		♠
♥ KQJ		♥ KQJ
♦ KQ		♦ KQ
♣		♣
	♠ A (squeeze card)	
	♥ xx (second card required for "A")	
	♦ AJ (protected threat)	
	♣	

Hearts is the CLA suit, headed by a protector. There are two losers, but the "squeeze without the count" comes through. Any club winner or exit card in the squeezee's hand was stripped out on the last trick. The

squeeze will not work with three or more losers if the defender can kill the position upon winning the duck trick, or if the defender has an exit card. Note that the ace of spades could have been in either hand, that South must have two hearts for “L” and “A” of CLA, and that the diamond protector is necessary.

	♠ 3	
	♥ AQ432 (CLA threat)	
	♦	
	♣ 4	
♠		♠
♥ 10		♥ J987
♦ 1098		♦ 5
♣ 732		♣ KQ
	♠ A (squeeze card)	
	♥ K65	
	♦ 6	
	♣ AJ (protected threat)	

South needs all but one trick to make a notrump contract, but with two losers there is no heart-club squeeze. With no way to rectify the count for a simple squeeze, do the hearts have to run? Not if the heart holder must guard clubs too. The Strip and Duck, which works with two losers, saves the day. South cashes the spade ace, stripping East out of a diamond exit. South then cashes the heart king, leads a low heart, and ducks when West shows out. The squeeze works with the East-West hands reversed, but you would have to be sure of the distribution (as when West started with five hearts) in order to duck a heart on the second round.

Note the unblocking of the heart suit. If South carelessly plays a high heart from the North hand before playing the king, the duck results in a blocked suit. Also, if all three heart protectors were in the North hand, declarer should try to play one of them early. Just one, no more. Then the second round of the suit (led from the South hand) can be ducked when West shows out. If one heart has not been cashed earlier, West would follow to the first heart and declarer would not know to duck the trick.

Topless Strip

The Topless Strip version of the Strip and Establish has the same requirements as the Strip and Duck, except that the CLA threat has no protector-entry. There are four possibilities:

- (1) both threats over the squeezee, squeeze card opposite;
- (2) CLA threat over the squeezee, split threat under the squeezee;
- (3) protected threat over the squeezee, CLA threat under the squeezee, no side entry
- (4) threats not in the same hand, and CLA threat hand has an entry in the protected threat suit.

(1) Both threats over the squeeze, squeeze card opposite. Only West can be squeezed:

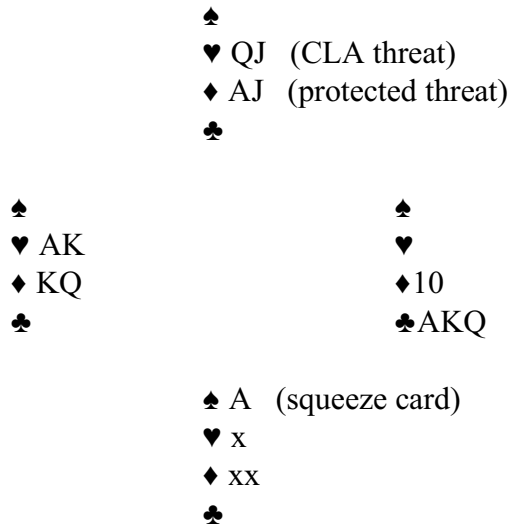

In this spade contract, "A" of CLA is provided by the diamond ace. With both threats in the North hand, only West can be squeezed. West was stripped of a club on the last round.

Had the contract been in notrump, or if South had a small club, West could have foiled the squeeze by throwing a heart on the previous trick and hanging onto a club. Unlike the Strip and Endplay, a Topless Strip cannot always squeeze an opponent out of a side suit winner (or fast entry to partner's winner), even with just two losers.

(2) CLA threat over the squeeze, split threat under the squeeze. In the preceding diagram, exchange the jack of diamonds with a small diamond in the South hand, producing a split threat. Again, the spade ace squeezes West:

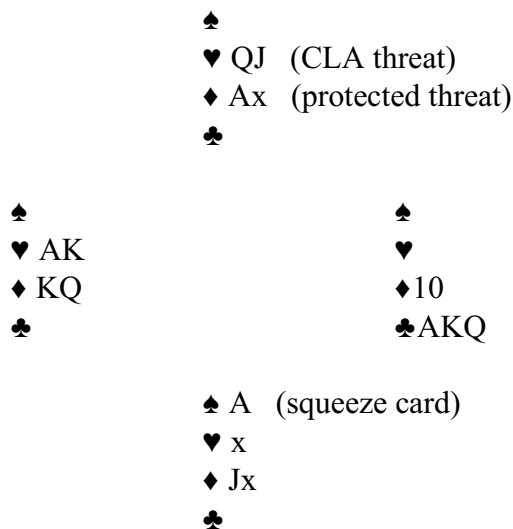

(3) When the squeeze sits over the CLA threat, the other hand must have two cards in that suit (for "L" and "A" of CLA), along with a protected threat::

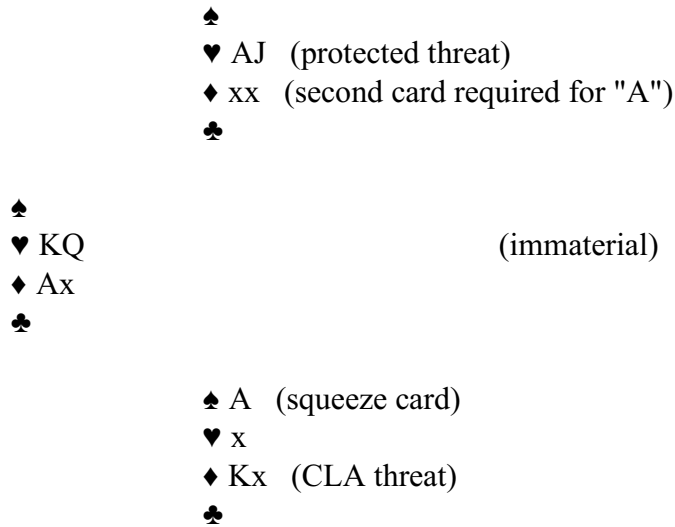

When the spade is led and West lets go of a diamond, the heart jack is thrown from the North hand. Declarer then knocks out the diamond ace with the small diamond ("L"), and there is a second diamond in dummy for return to the king ("A"). Here too only West can be squeezed.

(4) When the threats are divided between the two hands, and the CLA threat hand has an entry in the other threat suit, either opponent can be squeezed and the squeeze card can lie in either hand:

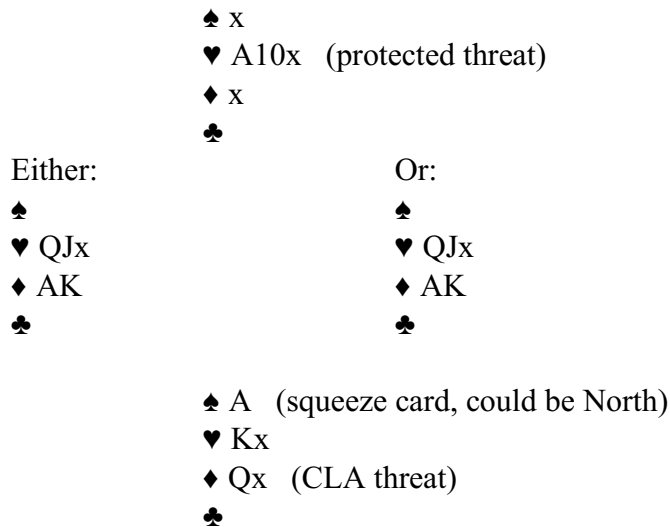

When the spade is led, the squeeze must either unguard the heart threat or give up a diamond guard. The red suits could be switched between North and South, with the same squeeze operative.

Suppose a CLA suit requires multiple concessions? Then you need an extra protector in the other threat suit for each extra concession, and the losing trick count rises by one for each, as in this notrump contract with three losers remaining:

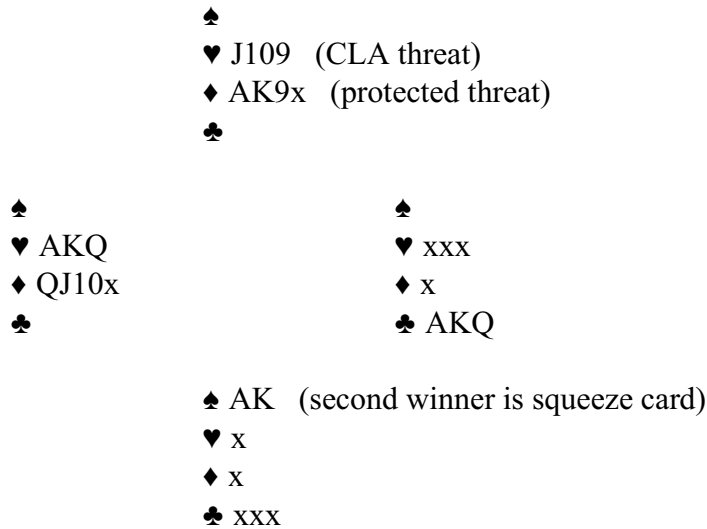

West safely throws a diamond on the first spade winner, and a diamond is also discarded from the North hand. On the lead of the last spade winner, West no doubt throws a heart, so declarer discards dummy's nine of diamonds. With the two diamond protectors declarer has time to concede two heart tricks. If one of the diamond protectors were exchanged for a club in the South hand, another heart would be needed in the South hand to lead ("L") for the second concession.

The squeeze would fail if West had a club exit card in place of that fourth diamond. If West had AKQJ in hearts and North 10xxx, North would need three diamond protectors for a triple concession!

The Vise

The Vise strip squeeze compresses an opponent's cards needed to protect the partnership's combined holding. A common case is an opponent's holding of QJ opposite partner's ace:

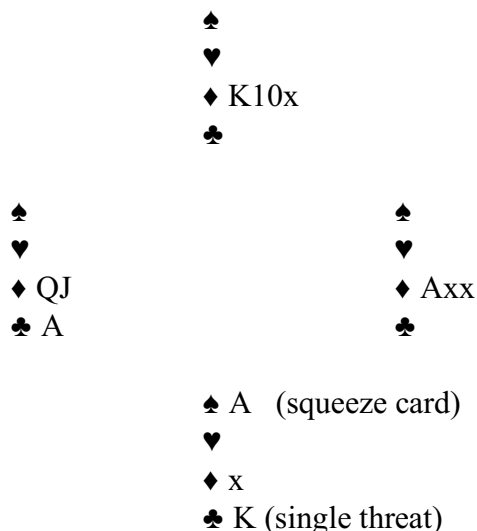

West has been stripped of any side winner. When South leads the ace of spades, West's diamonds are caught in a vise. If East had a side winner, the squeeze would fail. If the club king had been in the North hand, it could not be reached when West throws the ace of clubs, and the squeeze would also fail. When the side-suit threat lies opposite the squeeze card, it must be a protected threat:

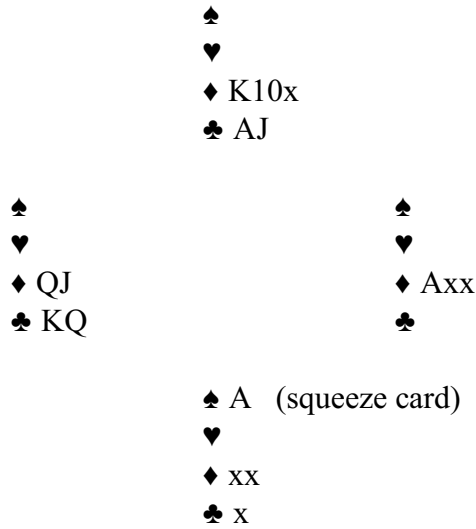

Now if West unguards clubs, the club threat protector provides entry to the established threat. Note that in this case the 10 of diamonds could just as well have been in the South hand.

Another vise possibility is a holding of Jx opposite Kx, LHO holding the queen. The squeeze's protective cards do not always have to be touching cards.

A fairly common holding for a vice squeeze is (K)(Q)9x opposite (Q)(K)xx, with the 9 (or the 8, if the opposite hand has the 9) over the squeeze, who holds the J10:

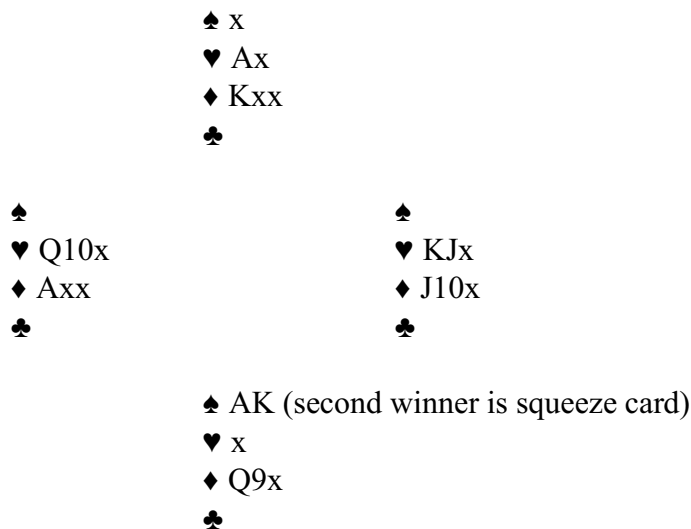

A diamond is led to the king, and then both spades are cashed. When the second spade is led, diamond from North, West must unguard hearts, and then East's diamonds are put in a vise. The jack or 10 must be discarded in order to guard hearts. The diamond queen then smothers East's last diamond, making the 9 high.

This can be called a double vice squeeze, since both opponents must guard hearts. If West had a side-suit winner (perhaps erroneously discarded on the previous trick), the squeeze would fail.

Cashing both spades first also works, however. This is the position:

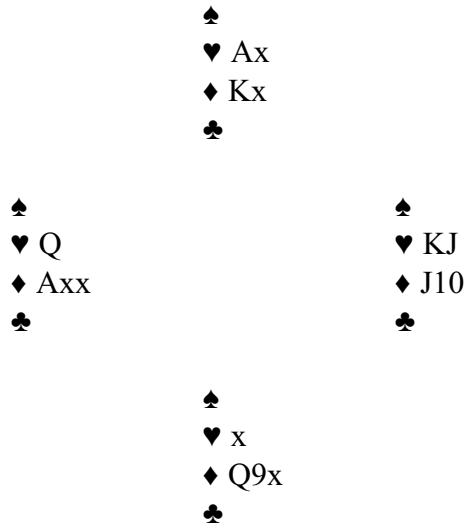

South now leads a low diamond. If West hops up with the ace, the king is played under it. If he ducks, the ace of hearts is cashed and a diamond led. With the J10 of diamonds squeezed down to one card, the diamond 9 is established in either case.

When the squeeze's partner will be forced to lead to the established CLA threat, that provides the "A" of CLA. Example suggested by Alvin Bluthman:

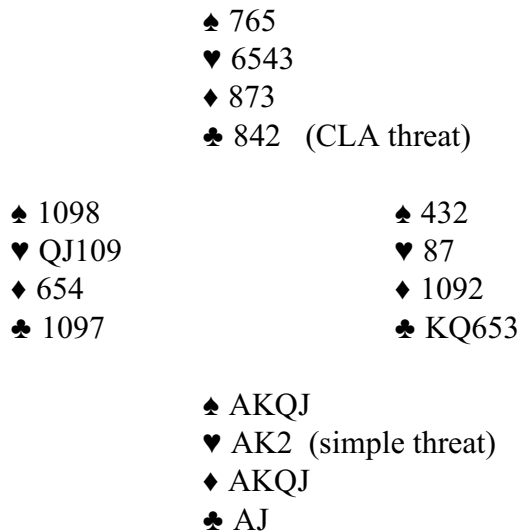

After South takes a flyer and bids slam in notrump, things look pretty bleak after the lead of the club 10, but if West has led from the 109 and holds four hearts there is a likely squeeze.

South starts off by cashing the spades and diamonds, of course. The last of these is played from this position::

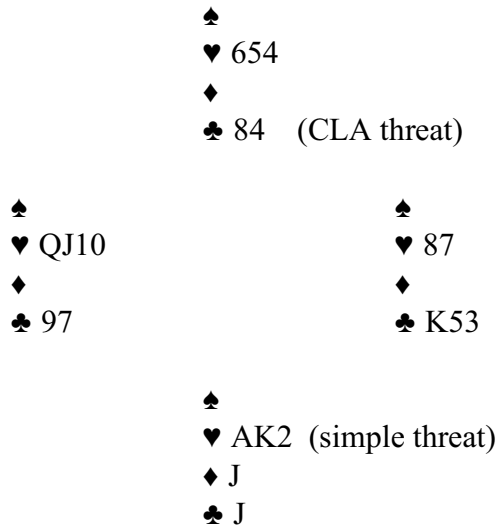

If West throws a heart on the jack of diamonds, declarer has three heart tricks. If he throws a club, declarer throws a heart from dummy, cashes the AK of hearts to remove East's exit card, and leads the jack of clubs. The club 9 is smothered and East must lead a club to dummy's good 8 after winning the king.

This could be called a Lunar Squeeze, comparing the featureless dummy to a barren moonscape. A "lunar landing" seems impossible, but is nevertheless achieved. Actually it is a form of Stepping-stone Squeeze, the club king being used as a steppingstone to the club 8.

The Winkle

The winkle can threaten opponents with turning a two-loser suit into a one-loser suit, and sometimes accomplishes that. It takes advantage of the inability of the opponents to untangle a suit blockage in the two-loser suit. It comes in handy for certain positions in which declarer has not enough transportation to cash the tricks he has coming. Or, an opponent may be unable to avoid an endplay without giving up a trick in the two-loser suit.

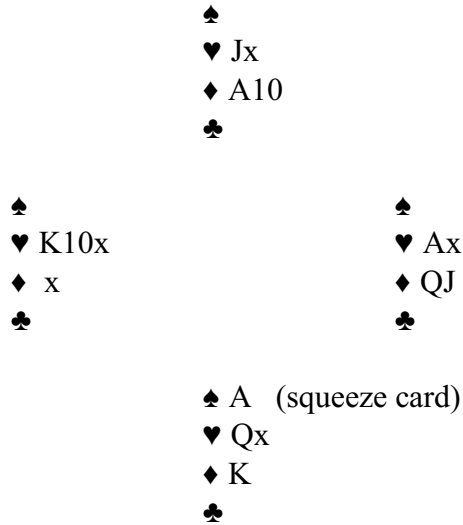

Declarer has three tricks in high cards, but no way to cash them. East has already been stripped of a high club. When the ace of spades is cashed and a heart thrown from dummy, East is fixed. A diamond discard is instant death, a low heart enables declarer to cash the king of diamonds and use the ace of hearts for a steppingstone to the ace of diamonds, and unblocking with the ace of hearts allows declarer to winkle out a heart trick. Here is a winkle against a vulnerable stopper:

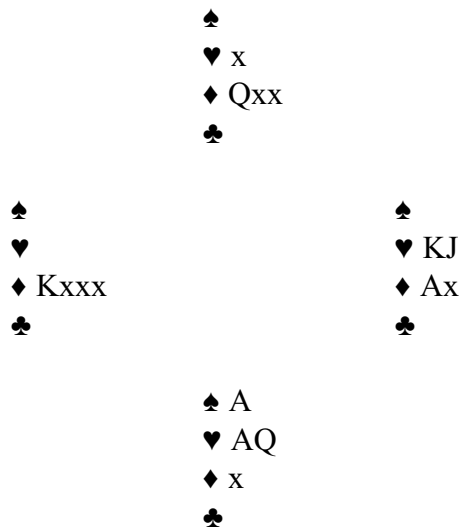

With the lead in the South hand and no entry to dummy, it looks as if declarer cannot take the heart finesse and will lose two tricks. However, East must throw the ace of diamonds on the ace of spades or be endplayed in hearts. The ace of hearts is cashed and a diamond lead then winkles out a trick in diamonds.

THREE-SUIT STRIP SQUEEZES

Three-suit strips may gain two tricks in a number of ways, often as a result of a mistake by the defender, sometimes by force:

- Defender leads from a doubleton into major tenace of an extended CLA threat (yielding two tricks immediately).
- Defender unguards an extended threat (yielding two tricks immediately).
- Extended CLA threat suit yields two tricks after a duck.
- Another squeeze position develops after one trick has been gained (e.g., a two-suit, two-loser strip squeeze).

Three-Suit Strip and Endplay

This squeeze requires:

- Three threats against one opponent, often including one or two CLA threats.
- At least one threat is against a weak guard.
- Entry to established threat(s).
- An entry to squeezee's hand for the endplay.
- At most three losers remaining, unless the squeezee has no exit card.

The three-suit Strip and Endplay is guaranteed to gain a trick with just three losers in hand, but any number of losers are okay if the defender has no exit card. If the loser count is three, the defender will be squeezed out of any such exit card as well as any winners but two. It is therefore best to rectify the count down to three losers whenever practicable, although it is rare that the squeezee has an exit card anywhere among those three "busy" suits.

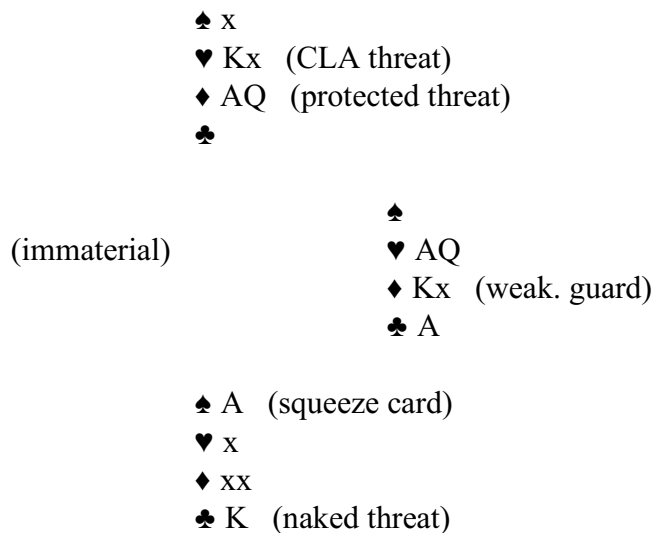

No matter what the squeezee throws on the spade ace, he gives up a trick. Note that there are three losers. The squeezee might have done better to blank the diamond king earlier, keeping another heart. If he mistakenly

throws the club ace in this position, declarer gains another trick with a two-suit strip squeeze (throwing the small heart on the king of clubs).

A nice feature of this type of squeeze is that it works against either defender and threat location is immaterial. A bad feature is the ambiguity that may arise if the squeezee discards shrewdly.

Three-Suit Strip and Establish

This squeeze requires:

- Three threats against one opponent, including:
- A CLA threat, protector optional (unless needed for entry).
- At least one other threat is protected.
- Entry to established threat(s).
- Just three losers remaining, unless the squeezee has no exit card.

There may be more than one CLA threat. When the squeeze is complete, declarer will lead a CLA suit to establish a winner there if no other threat has been unguarded.

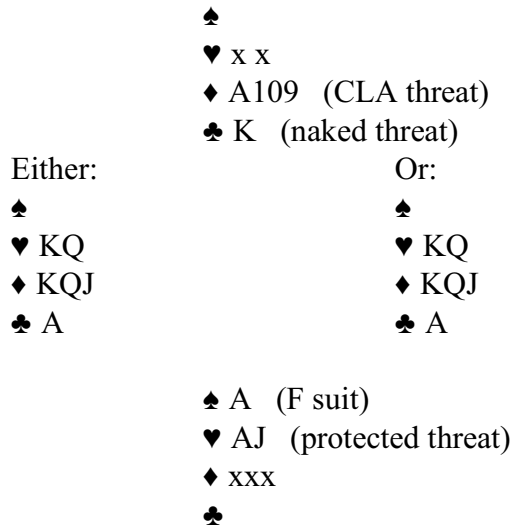

When the spade ace is cashed and a heart played from dummy, the squeezee must let go a diamond. A diamond is then ducked. The squeezee can cash the high club, but that is all. One trick gained. Note the need for at least two diamonds in the South hand, for access (A) to the established diamond after the duck.

If the other threats were switched, South would need only one diamond and the CLA threat would not need a protector-entry (Topless Strip):

	♠	
	♥ AJ (protected threat)	
	♦ QJ (CLA threat)	
	♣ x	
Either:		Or:
	♠	
	♥ KQ	
	♦ AK	
	♣ A	
	♠ A (squeeze card)	
	♥ xx	
	♦ x	
	♣ K (naked threat)	

South is declarer in a notrump contract. The squeeze must yield a diamond on the squeeze trick, North throwing a club, enabling the diamond threat to be established after conceding a trick. If West discards the high club (unlikely) the king of clubs becomes the squeeze card for another (Sinister) squeeze. A second squeeze won't work against East, who sits over dummy's threats.

Two tricks could always be gained against West if the CLA threat were extended and both of the other threats protected:

	♠	
	♥ AJ (protected threat)	
	♦ A987 (extended CLA threat)	
	♣ x	
Either:		Or:
	♠	
	♥ KQ	
	♦ KQJ	
	♣ KQ	
	♠ A (squeeze card)	
	♥ x	
	♦ xxx	
	♣ AJ (protected threat)	

The squeeze had to part with the diamond 10 on the previous trick. If West unguards diamonds, a diamond duck gains two tricks; if clubs, two rounds of clubs squeezes again; if hearts, two good hearts squeeze again.

East cannot be squeezed a second time, no matter what is played from North on the squeeze card. He can unguards clubs, and (since he is sitting over the red-suit threats) there is no squeeze when the two good clubs are cashed.

♠ xx
 ♥ Jx (split threat)
 ♦ AKQxx (CLA threat)
 ♣ Kxxx

♠ 8xx	♠ KQJ9x
♥ 10xxxx	♥ KQx
♦ x	♦ J1098
♣ J1098	♣ x

♠ A10x (threat)
 ♥ A9x (split-threat protector)
 ♦ xxx
 ♣ AQxx (F suit)

After dealer East opens the bidding in first seat with one spade, and therefore surely has KQ of hearts, South plays three notrump. With 11 likely tricks, declarer ducks East's jack when the 8 is led, hoping to make 12 tricks via a squeeze. After taking the second spade, declarer plays the ace and king of clubs, revealing the bad split and at the same time stripping East of the small heart. Declarer then cashes just one high diamond before leading to the club queen (East contributing a spade winner). Now declarer leads a diamond, ducking when West shows out. Having been compelled to throw a spade, East can now cash only two spades, so South makes the contract.

Note that the squeeze works with four losers, and would have worked with five (declarer taking the first spade). The reason is that East's potential exit card (a small heart) is not a "fast exit," which is needed in this situation. Also note the necessity for cashing one, and only one, high diamond. Otherwise declarer wouldn't know that East started with four diamonds when the second round is led.

A heart switch by East at trick two defeats the contract. If South ducks twice, East switches back to spades, killing any squeeze (provided West doesn't discard a spade on the second diamond, which would allow declarer to concede a club trick safely, rectifying the count for a simple squeeze of East in spades and diamonds). It follows that declarer should not duck the first spade, since if both diamonds and clubs run there is a two-suit two-loser Strip and Duck squeeze, for 12 tricks (CLA in spades, split threat in hearts). There is no need to rectify the count for this squeeze, because it *is* rectified!

Although this squeeze is guaranteed to work with three losers, it usually works with more, as in the preceding deal. Sometimes four losers are better than three!

♠ AJx (protected threat)
 ♥ xx
 ♦ KQ108x (protected threat)
 ♣ KQx (F suit)

♠ xxx	♠ Qxx (weak guard)
♥ 32	♥ KQJ109
♦ x	♦ J9xx (weak guard)
♣ Jxxxxxx	♣ x

♠ Kxxx
 ♥ Axxx (CLA threat)
 ♦ Axx
 ♣ Ax

South plays four notrump in a matchpoint game after East overcalls one heart and a four notrump slam try is passed. West leads the heart eight and South sees that if East has diamonds and spades stopped there are four losers, putting the contract in jeopardy. With two threats against possible weak guards in spades and diamonds, and a CLA threat in hearts, South might consider ducking the heart lead to rectify the count down to three losers for a three-suit Strip and Duck. However, the hand containing the last F winner (North's last club) must have a CLA card to lead (the "L" in CLA) when the squeeze is complete. Otherwise (assuming hearts are continued) no CLA, and the squeeze will gain only one trick. Taking the first trick retains the "A" of CLA and a two-trick gain for an important overtrick, even with four losers.

If South had possessed a third club (so the club ace could be the last F winner), or North a third heart, the duck would not hurt.

Here's a case in which four losers are too many:

♠ x
 ♥ x
 ♦ AJ (protected threat)
 ♣ Axx (split-threat protector)

♠	♠
♥ QJ	♥
♦ KQx	♦ 10xxx
♣ KJ	♣ 10xx

♠ A
 ♥ 10x (threat)
 ♦ xx
 ♣ Qx (split threat)

South is on lead. There are threats in three suits, but the heart threat lacks access ("A") for cashing if established. West can throw a heart on the spade, and when in with the queen of hearts can lead the king of

diamonds. Holding the small diamond as an exit card, West cannot be endplayed. However, if the ace and queen of clubs were exchanged, providing “A” to the established heart, a trick would be gained.

Had declarer been able to concede a trick earlier, this would be the three-loser situation:

	♠ x	
	♥	
	♦ AJ (protected threat)	
	♣ Axx (split-threat protector)	
♠		♠
♥ QJ		♥
♦ KQ		♦ 10xxx
♣ KJ		♣ 10xx
	♠ A	
	♥ 10x (threat)	
	♦ x	
	♣ Qx (split threat)	

The heart threat still lacks access, but after discarding a heart on the spade ace West has no diamond exit card to partner’s hand. West can lead the king of diamonds after being thrown in with a heart, but is then endplayable by another diamond lead.

DOUBLE SQUEEZES

In a double squeeze, both opponents are squeezed for a gain of one trick. First one opponent is squeezed out of a guard, thereby making partner's hand subject to a simple squeeze.

The standard requirements for all double squeezes are:

- One loser remaining
- One single threat over each opponent ("R" and "L" threats)
- One protected double threat ("B" threat) vs both opponents
- If all B-threat protectors are in the B-threat hand, squeeze card must lie opposite.

There are three general types of double squeezes:

Type R - one hand's only threat is a lonely single threat

Type B1 - one hand's only threat is a double threat headed by one protector

Type B2 - one hand's only threat is a double threat headed by two protectors

Type R Double Squeeze

In this squeeze the R threat is "lonely" (only threat in its hand), opposite the other two. Winners other than those in the B suit can be cashed in any order, but the last such winner must be led from the R-threat hand.

	♠	
	♥ K (L threat)	
	♦ Ax (B threat)	
	♣	
Lth Hand		Rth Hand
♠		♠
♥ A		♥
♦ KJ		♦ Q10
♣		♣ A
	♠ A (F suit)	
	♥	
	♦ x	
	♣ K (lonely R threat)	

West throws a diamond on the spade ace, North discards the now useless heart, and East is helpless. This is called a "simultaneous double squeeze," because both opponents are squeezed on the same trick. This happens when all R and L threat winners are cashed before the last F winner.

If the last non-B winner is in the wrong hand, the squeeze fails:

	♠	
	♥ AJ (L threat)	
	♦ Axx (B threat)	
	♣	
Lth Hand		Rth Hand
♠		♠
♥ KQx		♥
♦ KJ		♦ Q10
♣		♣ KQx
	♠ A (F suit)	
	♥ x	
	♦ x	
	♣ AJ (lonely R threat)	

When the spade ace is cashed, West discards a diamond, East discards a club, and the squeeze fails for lack of a reentry to the South hand after cashing the heart ace. Had the heart ace been cashed earlier (too late now), a double squeeze would have developed.

Had the heart ace been in the South hand, this would be the situation:

	♠	
	♥ Jx (L threat)	
	♦ Axx (B threat)	
	♣	
Lth Hand		Rth Hand
♠		♠
♥ KQx		♥
♦ KJ		♦ Q10
♣		♣ KQx
	♠ A (F suit)	
	♥ A	
	♦ x	
	♣ AJ (lonely R threat)	

Now declarer can cash the three non-B winners in any order and the squeeze still works, because they are all in the R-threat hand, from which the last B-winner must be cashed in a type R double squeeze.

Type L Double Squeeze?

There is no such thing as a plain type L double squeeze, because if a single threat is alone, it must be an R threat. Otherwise the location of threats is such that no squeeze is possible:

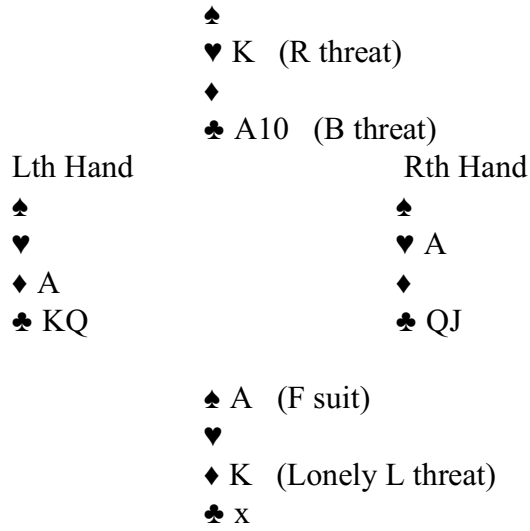

On the play of the ace of spades, West is squeezed out of a club guard, but dummy is squeezed before East.

Type B1 Double Squeeze

In this squeeze the B threat is alone, headed by one protector. The last F winner must lie in the hand with the B threat, and the last R protector must be cashed before the last F winner. There are two versions, the “unrestricted” version and the more difficult “restricted” version.

A. **Unrestricted** - Other hand has a B protector also, with a small card

- Cashing last L protector(s) early is advisable.
- Last R protector must precede the last F protector
- If L or R threat not established, go to B suit.

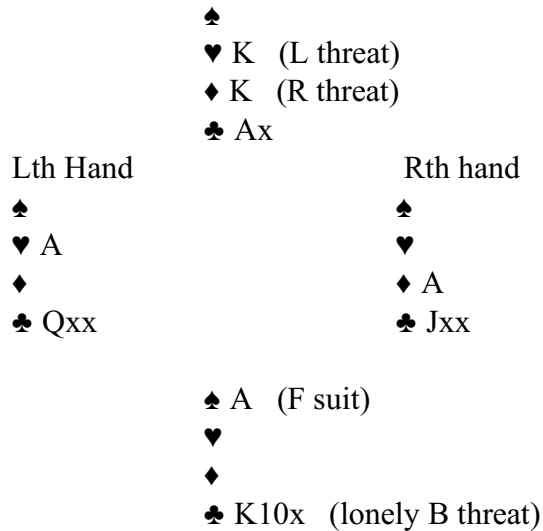

This is another easy "automatic" squeeze if you know who guards which single threat. If West throws a club, North discards the single threat guarded by West (perhaps having to guess which threat that is). East is then squeezed. The position shown produces a guard squeeze (see next chapter) if West guards both single threats and has either of the outstanding club honors. West would not be able to protect East's club honor from a finesse.

L protectors can theoretically be cashed at any time, but the last R protector must precede the last F winner. If North's diamond threat were a protected threat with an uncashed protector, the squeeze would fail, but a heart protector there (which would ultimately squeeze East) would do no harm.

Let's look at the failing case, with an uncashed R protector:

	♠	
	♥ K (L threat)	
	♦ AJ (R threat)	
	♣ Ax	
Lth Hand		Rth hand
♠		♠
♥ A		♥
♦ x		♦ KQ
♣ Qxx		♣ Jxx
	♠ A (squeeze card)	
	♥	
	♦ x	
	♣ K10x (lonely B threat)	

Having neglected, or been unable, to cash the last R protector (diamond Ace), declarer has no squeeze. West can discard a diamond on the spade, and dummy is squeezed. Declarer should have cashed the ace of diamonds earlier.

An uncashed L protector does not have this problem:

	♠	
	♥ AJ (L threat)	
	♦ K (R threat)	
	♣ Ax	
Lth Hand		Rth hand
♠		♠
♥ KQ		♥ x
♦		♦ A
♣ Qxx		♣ Jxx
	♠ A (squeeze card)	
	♥	
	♦ x	
	♣ K10x (lonely B threat)	

When the spade ace is cashed, West yields a club, the jack of hearts is thrown, and East throws a heart. Now a club to the ace, and the ace of hearts squeezes East.

B. Restricted - Other hand has no B protector

- L entry (squeeze card) is required opposite last F winner.
- Which suit is R, which is L, may be ambiguous.
- The last of any R protectors must precede the last F winner, which must precede the last L protector (“RFL”).
- An entry to the South hand is required after cashing any R protector in the North hand (to preserve a line of communication, perhaps via next-to-last F winner).

	♠ x ♥ AJ (R threat) ♦ x ♣ AJ (L threat, final squeeze card)
Lth Hand	Rth Hand
♠ ♥ xx ♦ KJ ♣ KQ	♠ ♥ KQ ♦ Q10 ♣ xx
	♠ AK (F suit) ♥ x ♦ Ax (lonely B1 threat) ♣ x

At this point South must *not* cash a spade; a spade entry is needed for return after the mandatory cashing of the R protector. The sequence is heart ace (R), spade king, spade ace (F, initial squeeze card), club ace (L, final squeeze card).

If the R protector is not cashed, or lack of communication prevents its cashing, the squeeze fails. This would be the position when the last spade is to be cashed:

	♠ ♥ AJ (R threat) ♦ x ♣ AJ (L threat, final squeeze card)
Lth Hand	Rth Hand
♠ ♥ x ♦ KJ ♣ KQ	♠ ♥ KQ ♦ Q10 ♣ x
	♠ A (F suit) ♥ x ♦ Ax (lonely B1 threat) ♣ x

West discards a heart and the North hand is squeezed out of a threat or the necessary small diamond.

The needed reentry to the South hand after cashing R protector(s) in the North hand may be a protector in either the R or L threat suit instead of the F suit. In that case one F winner remaining is enough. "The last L" must be accessible at the end, and must lie in the North hand.

	♠	
	♥ A10x (R threat)	
	♦ x	
	♣ AJ (L threat, final squeeze card)	
Lth Hand		Rth Hand
♠		♠
♥ xx		♥ QJx
♦ KJ		♦ Q10
♣ KQ		♣ x
	♠ A (F suit)	
	♥ Kx	
	♦ Ax (lonely B1 threat)	
	♣ x	

Here the needed reentry to the South hand is in the R suit. The sequence is ace of hearts, king of hearts (cashing R protectors early), spade ace (squeezing West out of a diamond), club ace (squeezing East).

	♠	
	♥ AJ (R threat)	
	♦ x	
	♣ A10x (L threat, final squeeze card)	
Lth Hand		Rth Hand
♠		♠
♥ x		♥ KQ
♦ KJ		♦ Q10
♣ QJx		♣ xx
	♠ A (F suit)	
	♥ x	
	♦ Ax (lonely B1 threat)	
	♣ Kx	

Here the needed entry to the South hand is in the L suit. The sequence is ace of hearts (R), king of clubs, spade ace (F), squeezing West out of a diamond, North discarding a club, club ace (L, squeezing East). Cashing the king of clubs before the last F is okay because it is not the last L protector.

This squeeze is more difficult than those preceding, not only because of the strict sequence in which final winners must be cashed (R, F, L), but also because declarer may not be sure who is guarding which suit. Which threat is L, which is R? Declarer has to know this in order to cash winners in the correct order.

Suppose the opposing cards are distributed like this instead::

	♠	
	♥ AJ (L threat, final squeeze card)	
	♦ x	
	♣ A10x (R threat)	
Lth Hand		Rth Hand
♠		♠
♥ KQ		♥ x
♦ KJ		♦ Q10
♣ xx		♣ QJx
	♠ A (F suit)	
	♥ x	
	♦ Ax (lonely B1 threat)	
	♣ Kx	

Now the L and R suits are switched, so the sequence of play must be ace of clubs (R), king of clubs, spade ace (F, squeezing West out of a diamond), heart ace (L, squeezing East).

In all these variations, when the squeezed Lth hand chooses to keep the L suit guarded, the threat in that suit (heart jack, above) becomes useless and is discarded. In fact, it is the only discard that will preserve the squeeze against the Rth hand.

Rule for all B1 type double squeezes: **CASH R PROTECTORS EARLY!**

Type B2 Double Squeeze

In this squeeze the B threat is alone, headed by two or more protectors. The squeeze may be “simultaneous,” both opponents squeezed on the same trick, or “non-simultaneous,” each opponent squeezed on a different trick

A. **Simultaneous B2** - last F winner opposite the B2 threat:

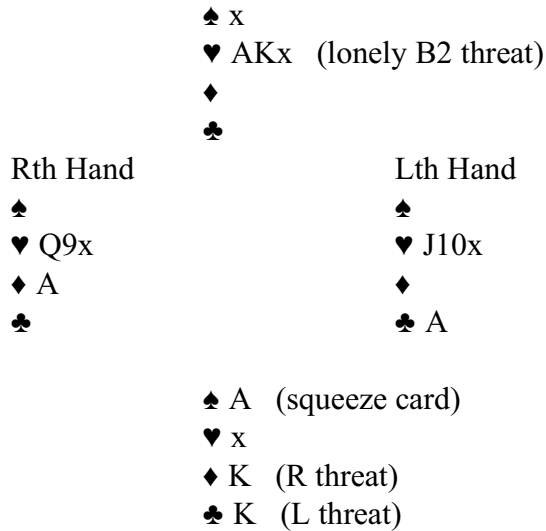

This is the easiest sort of double squeeze. Any R/L protectors in the B2-threat hand are cashed first. If neither the R nor the L threat is established when the spade ace is played, run the hearts. No need to watch heart discards, only R and L. Doesn't matter who guards R and L threats, just so the guards are split. The last F winner squeezes both opponents simultaneously (i.e, on the same trick).

B. Non-Simultaneous B2 - last F winner in same hand as B threat

- At least one L or R entry must lie opposite the B threat.
- L/R protectors in the B-threat hand must be cashed first.
- Cashing of last L/R protector comes after the last F winner.
- Last R/L protector opposite B2-threat hand is the final squeeze card.

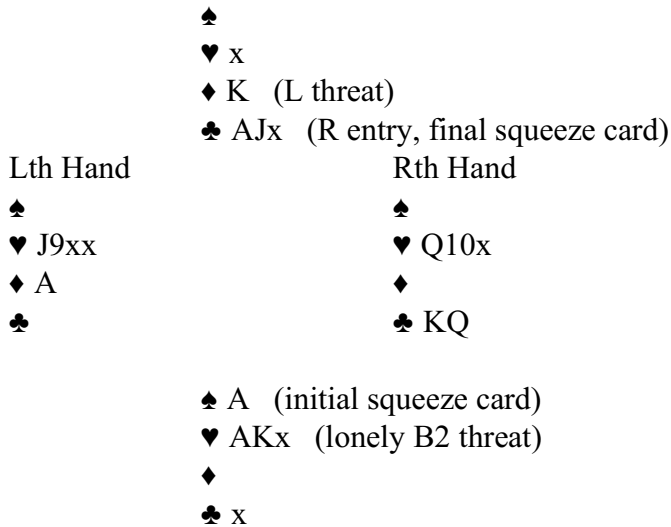

This too is an easy "automatic" squeeze. Both opponents are squeezed, but not on the same trick. After the last F is cashed, squeezing East out of a heart, North's ace of clubs squeezes West.

Another example, this time with an L protector opposite the B2 threat:

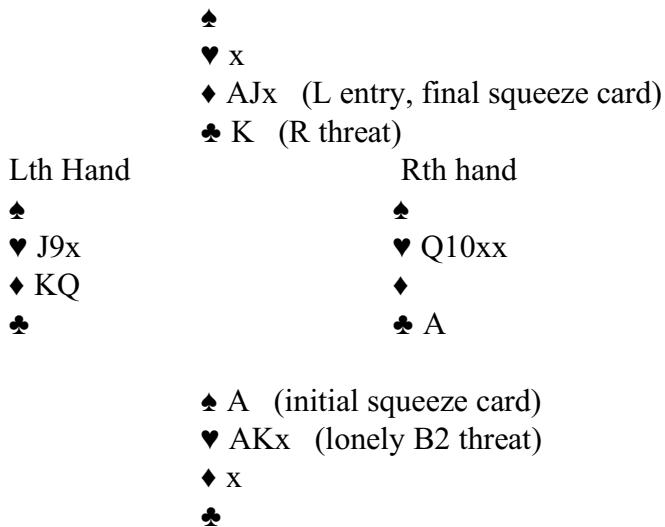

The spade ace squeezes West out of a heart, after which the diamond ace squeezes East.

And one with L and R protectors both North and South:

	♠	
	♥ xx	
	♦ A9x (L threat)	
	♣ A9x (R threat)	
Lth Hand		Rth Hand
♠		♠
♥ J10xx		♥ Q9xxx
♦ QJ10x		♦
♣		♣ QJ10
	♠ A (initial squeeze card)	
	♥ AKx (lonely B2 threat)	
	♦ Kx	
	♣ Kx	

The spade ace should be cashed early (North discarding a heart). The L and R protectors may be cashed in any order, but at least one L or R entry (either one) in the North hand must be saved until all other L, R, and F winners are cashed. That last winner is the final squeeze card.

This is the ending if the diamond honors are cashed, followed by the king of clubs:

	♠	
	♥ x	
	♦ 9 (L threat)	
	♣ A9 (R threat)	
Lth Hand		Rth Hand
♠		♠
♥ J10x		♥ Q9
♦ Q		♦
♣		♣ QJ
	♠	
	♥ AKx (lonely B2 threat)	
	♦	
	♣ x	

East had to throw a heart on the second diamond winner. The ace of clubs has been saved for the last. It is now cashed, squeezing West out of a heart guard. The small heart is now a winner.

If the club honors are cashed, followed by the king of diamonds, this is the ending:

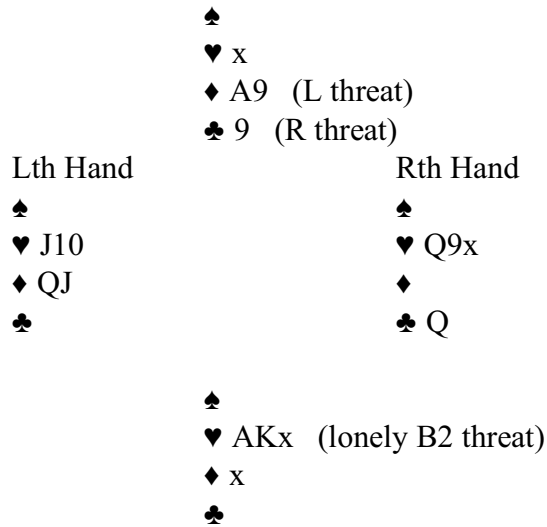

West had to throw a heart on the second club. The ace of diamonds has been saved for the end. It is now cashed, squeezing East out of a heart guard. South's small heart is then a winner.

B2 squeezes have one great advantage. It is not necessary to know who guards which threats. Just run all winners outside the B suit, ending in the hand opposite the B2 threat, watching to see whether an L or R threat has become established. If not, cash the B protectors and hope the last card is good.

Simple Squeeze Played as a Double Squeeze

In all of these double squeeze positions, a double threat may actually be guarded by only one opponent. In fact, some threats (e.g., KQxx opposite Ax) can only be guarded by one opponent. This makes absolutely no difference in the squeeze techniques involved. Declarer merely plays the hand as if it were a double squeeze. Since only one opponent is actually squeezed, it is really a simple squeeze masquerading as a double squeeze, but the principles are the same.

GUARD SQUEEZES

In a guard squeeze, an opponent is pressured in three suits, in one of which he holds a card (finesse guard) that protects partner from a finesse. The general requirements are:

- One loser remaining (all the tricks but one)
- A basic threat (guarded by its RHO only)
- A holding that includes a potential finesse possibility (finesse threat)
- A third threat
- The finesse threat must be accompanied by only one protector when the squeeze card is played.
- The finesse threat must not be blocked.

A guard squeeze can sometimes be executed when a compound squeeze (described in a later chapter) is not possible because one of the required double threats lacks a protector, or the necessary entries are lacking.

We skip over simple guard squeezes, because they work the same as double guard squeezes, which are of two types: Type R and Type L.

Type R Double Guard Squeeze

In this squeeze a lonely basic threat lies opposite the finesse threat and a third threat. The defender sitting over the finesse threat must guard partner from being finessed. A compound squeeze is not possible because the third threat is not accompanied by a protector.

	♠ x ♥ A9 (must be one protector only!) ♦ Q (unprotected B threat) ♣	
Lth Hand		Rth hand
♠ ♥ Q82 ♦ K ♣		♠ ♥ K (finesse guard) ♦ A ♣ KQ
	♠ A (squeeze card) ♥ x (must be smaller than the 9, for a finesse) ♦ ♣ AJ (basic threat)	

East has already been squeezed down to the heart king, changing a double threat into a finesse threat. When declarer plays the squeeze card, East cannot protect West from a finesse without giving declarer an easy simple squeeze in diamonds and hearts or two club tricks. Note that the finesse threat holding must have one protector only, so cash all but one protector early if it has more. The card led for the finesse must be smaller than the second highest card opposite, which may call for an earlier unblocking play. The basic threat protector is required at the time the squeeze card is played to provide sufficient space in the other hand for

its assets. There may be some ambiguity present (When East plays the heart king, who has the queen?). If in doubt, the Principle of Restricted Choice says to finesse in such situations.

If West lacked a diamond guard, this would be called a "simple" guard squeeze. If East lacked a diamond guard, this would be an easy double squeeze.

If North has the last F winner, South must have an extra entry in any of the three threat suits to compensate:

	♠ A (squeeze card)	
	♥ A9x (one protector only)	
	♦ Q (unprotected B threat)	
	♣	
♠		♠
♥ Qxxx		♥ Jx (finesse guard)
♦ K		♦ A
♣		♣ KQ
	♠	
	♥ K10x (unblock the 10!)	
	♦	
	♣ AJ (basic threat)	

In this case, the needed South entry is in the potential finesse suit. Declarer cashes the spade ace, discarding South's ten to unblock. East cannot protect West from the heart finesse without subjecting West to a simple squeeze or giving South two club tricks.

Note that the heart 10 must be thrown on the spade winner, to unblock for a possible finesse later. Players should get in the habit of discarding the middle card from honor-third whenever possible, so that playing the smallest card doesn't get to be too strong a habit. Eric Paulsen once discarded the 8 from K8x (opposite A7x), and this careful play ended in a guard squeeze when the hand sitting over the ace had Q109 and could not protect partner's jack from a finesse.

The required entry may be in either of the other non-finesse-threat suits:

♠ A (squeeze card)
 ♥ AJ (one protector only)
 ♦ Jx (B threat)
 ♣

♠	♠
♥ Kxx	♥ Q
♦ Kx	♦ Qx
♣	♣ KQ

♠
 ♥ x
 ♦ A
 ♣ AJx (basic threat)

Here the diamond ace is the required entry. An extra protector in the lonely threat suit (clubs), with small card opposite, could also provide the necessary entry.

If the potential finesse holding is headed by two protectors when the squeeze card is played, the squeeze won't work:

	♠ x	
	♥ AK9 (must be one protector only!)	
	♦ Q (B threat)	
	♣	
Lth Hand		Rth hand
♠		♠
♥ Jxx		♥ Qx
♦ A		♦ K
♣		♣ KQ

♠ A (squeeze card)
 ♥ 10x
 ♦ x
 ♣ AJ (basic threat)

South has the lead. When the spade ace is played, East can safely throw a heart. While cashing a heart winner then produces a finesse position, there is no way to get back to the South hand in order to take the finesse. Cashing the ace of hearts earlier (unblocking the 10), if possible, was necessary for a successful squeeze.

Type L Double Guard Squeeze

In this squeeze the finesse threat is lonely, in the hand with the last F winner (“South”). West must guard East from being finessed. The North hand must have an entry (to lead toward South’s finesse threat)

♠
 ♥ x
 ♦ Q (unprotected B threat)
 ♣ AJ (basic threat)

♠	♠
♥ Q	♥ Kxx
♦ K	♦ A
♣ KQ	♣

♠ A (squeeze card)
 ♥ AJ (finesse threat)
 ♦
 ♣ x

Here the required entry in the North hand is in the basic-threat suit. If West throws the heart queen, East is finessable. If West throws the diamond king, East is squeezable. In all type L squeezes, the basic threat is discarded when the squeeze is complete. Unless West discards a club, the small club has become useless and is discarded on the squeeze card.

When North's entry is in another suit, the basic threat does not need a protector.
 (49)

♠
 ♥ K93
 ♦ Q (unprotected B threat)
 ♣ K (unprotected basic threat)

♠	♠
♥ Q10x	♥ Jxx
♦ K	♦ Ax
♣ A	♣

♠ AK (squeeze card)
 ♥ A87 (one protector only)
 ♦
 ♣

Here the required entry is in the finesse-threat suit. North's hearts are not a finesse threat because the other two threats are in the same hand. Two unprotected threats, and the squeeze still works! West discards a heart on the first spade, dummy unblocks by discarding the heart 9, and East discards the small diamond. If West throws a diamond on the final squeeze card, East is squeezable in diamonds and hearts. He can't throw the club ace either, so he blanks the heart queen. As always in a type L squeeze, the basic threat (club king) is then discarded, dummy is entered with the heart king, dropping the queen, and the heart finesse is taken.

Alternatively, the required entry could be in the other threat suit:

	♠	
	♥ x	
	♦ Ax (B threat)	
	♣ K (unprotected basic threat)	
♠		♠
♥ Q		♥ Kx
♦ Qx		♦ Kx
♣ A		♣
	♠ A (squeeze card)	
	♥ AJ (finesse threat)	
	♦ x	
	♣	

The spade ace is cashed and West must yield a trick one way or another.

Rules for all guard squeezes:

- **UNBLOCK FOR THE EVENTUAL FINESSE!**
- **CASH DOWN TO ONE PROTECTOR ONLY IN THE FINESSE THREAT!**

TRIPLE SQUEEZES

Unlike a double squeeze, which squeezes both opponents, the triple squeeze has three threats against one opponent, at least one of which is headed by a protector, and usually requires that declarer have no more than two losers. The squeeze will sometimes "repeat," gaining a second trick when an established threat is cashed and the squeezee is squeezed again. This is called a "progressive squeeze" or a "repeating squeeze." Sometimes the squeeze gains two tricks immediately.

There are three situations, depending on whether "North" (the hand opposite the squeeze card) holds one, two, or three threats.

A. North has one threat, South two

- North must have an entry in any of the three threat suits.
- Gains one trick vs either defender.
- Cannot repeat vs West if he correctly unguards North's single threat.
- Repeats vs East if North has an entry in South's suit and South has an entry in one of North's.
- Repeats vs East if North has an entry in both of South's threat suits, and South has entries in any two threat suits.
- Repeats vs either opponent if North's threat is an extended threat.

In this deal North has an entry in North's threat suit and South has an entry in one of South's:

	♠ x
	♥ AJ (lonely protected threat)
	♦ xx
	♣
Either:	Or:
♠	♠
♥ KQ	♥ KQ
♦ KQ	♦ KQ
♣ A	♣ A
	♠ A (squeeze card)
	♥ x
	♦ AJ (protected threat)
	♣ K (naked threat)

South throws a diamond from the North hand on the spade ace, and whichever card East discards, a second squeeze follows.

If West is the squeezee, a heart can be discarded on the ace of spades and one trick taken later. However, a player in this situation, not seeing the South hand if South is declarer, will almost always discard one of the guards against the South threats, hoping that East can guard the suit. When South then cashes the established threat, West is squeezed again in the other two suits.

Suppose South did not have that diamond protector-entry:

	♠	
	♥ AJ (lonely protected threat)	
	♦ xx	
	♣	
Either:		Or:
♠		♠
♥ KQ		♥ KQ
♦ A		♦ A
♣ A		♣ A
	♠ A (squeeze card)	
	♥ x	
	♦ K (naked threat)	
	♣ K (naked threat)	

Either East or West can be squeezed only once if the heart threat is unguarded, but if a minor suit is unguarded another squeeze follows. If South is the declaring hand, the second squeeze is probable. Seldom will an opponent be able to realize that giving up a heart trick will save a trick on the next round.

When North lacks a protector-entry in North's threat suit, in order to squeeze East twice North must have an entry in both of South's threat suits, and South must have entries in any two of the three threat suits, as in this deal:

	♠	
	♥ Ax (threat suit protector-entry)	
	♦ Ax (split-threat protector-entry)	
	♣ Qxx (split threat, x discarded on ♠A)	
Either:		Or:
♠		♠
♥ QJx		♥ QJx
♦ Kx		♦ Kx
♣ Kx		♣ Kx
	♠ A (squeeze card)	
	♥ K10x (doubly-protected threat)	
	♦ Qx (split threat)	
	♣ A (split-threat protector-entry)	

As usual West can only be squeezed once unless he makes a mistake by not unguarding the threat on the left, in this case the club threat. After discarding a club, West would be sitting over both the heart and diamond threats, so no second squeeze. If West mistakenly unguards diamonds or hearts, he gets squeezed again. The defending rule in a case like this is to let go of the suit held on one's left, but if West cannot see the threats in the South hand (i.e., South is declarer), he is likely to unguard one of those suits and then get squeezed again when the established threat is cashed.

Any discard by East results in a repeated squeeze. If East abandons hearts, the repeat squeeze is of the Criss-Cross type when the hearts are cashed. If East abandons clubs, South cashes the ace of clubs, goes to the ace

of diamonds, and the queen of clubs squeezes East again in hearts and diamonds (Sinister Squeeze). If East abandons diamonds, the ace of diamonds is cashed, then the ace of clubs (Vienna Coup, unblocking), and the queen of diamonds produces a Back-Door Squeeze in clubs and hearts.

If one of those four required threat entries were absent, a second squeeze would not be available against East (assuming correct discarding). The possibilities are left as an exercise for the reader.

When North's lonely threat is an extended threat, the squeeze gains two tricks against either defender:

	♠	
	♥ AJ10 (extended threat)	
	♦ x	
	♣ x	
Either:		Or:
♠		♠
♥ KQ		♥ KQ
♦ A		♦ A
♣ A		♣ A
	♠ A (squeeze card)	
	♥ x	
	♦ K (naked threat)	
	♣ K (naked threat)	

If the squeeze discards a minor suit card, the squeeze is repeated by cashing that suit. If a heart is discarded, declarer gains two tricks immediately.

If there were three losers, the North threat would have to be an extended CLA threat to gain two tricks, and the South threats would both have to be protected:

	♠	
	♥ A1098 (extended CLA threat)	
	♦ x	
	♣ xx	
Either:		Or:
♠		♠
♥ KQJ		♥ KQJ
♦ KQ		♦ KQ
♣ KQ		♣ KQ
	♠ A (squeeze card)	
	♥ xx	
	♦ AJ (protected single threat)	
	♣ AJ (protected single threat)	

If the squeeze discards a minor suit card, the squeeze is repeated by cashing that suit. If the squeeze discards a heart, declarer gains two tricks immediately by ducking a heart. It gains two tricks because of those

protected single threats, which prevent the squeeze from cashing a trick when a heart is ducked after a heart discard. Note the need for two hearts in the South hand, for access (A) to the North hand after the duck.

B. North has two threats, South one

- North must have an entry in at least one of the three threat suits.
- Always gains one trick vs West, almost always vs East.
- Cannot repeat vs East if he correctly unguards South's threat (unless it is an extended threat).
- Repeats vs West if South has an entry in South's threat suit and North has an entry in either of North's.
- Repeats vs West if South holds winner-and-small in both of North's suits.
- Repeats vs either opponent if South's threat is an extended threat.

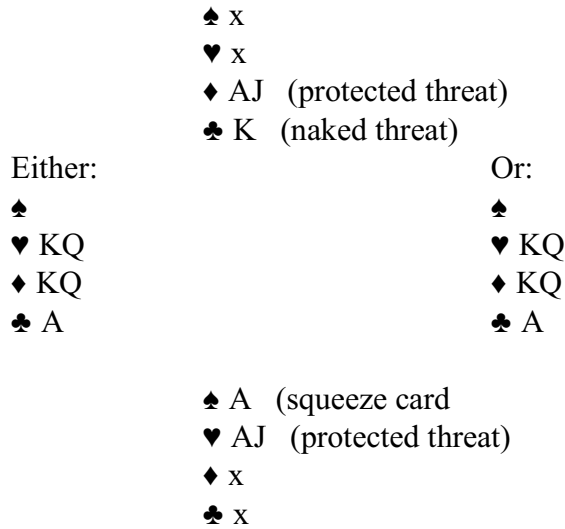

South has an entry in South's threat suit, and North has an entry in one of North's. No matter what West discards on the spade, he gets squeezed again by the cashing of the threat he unguards.

If East is the squeeze, he will not be squeezed twice if he unguards the heart threat.

	♠	
	♥ x	
	♦ A10x (protected threat)	
	♣ A10x (protected threat)	
Either:		Or:
♠		♠
♥ A		♥ A
♦ QJx		♦ QJx
♣ QJx		♣ QJx
	♠ A (squeeze card)	
	♥ K (naked threat)	
	♦ Kx	
	♣ Kxx	

South has no entry in South's threat suit, but has an entry and small card in both of North's. No matter what West discards on the spade, West gets squeezed again by the cashing of the threat that was unguarded.

As usual, East is saved from a second squeeze by unguarding the threat on the left (i.e., discard of the heart ace), but will East know to do that if South is declarer?

If North's only entry is in South's threat suit and South has no winner in either threat suit, the squeeze succeeds (for one trick) against West, but not against East:

	♠	
	♥ K (naked threat)	
	♦ K (naked threat)	
	♣ Ax	
Either:		Or:
♠		♠
♥ A		♥ A
♦ A		♦ A
♣ Kx		♣ Kx
	♠ A (squeeze card)	
	♥	
	♦ x	
	♣ Qx (split threat)	

When the spade ace is cashed, West must yield a trick, but cannot be squeezed again no matter which suit is unguarded. East cannot be squeezed at all, since the North hand must discard first and East can safely discard from the same suit.

East's defense of unguarding South's lonely threat usually suffices to avoid losing two tricks, but not if South's lonely threat is an extended threat:

	♠	
	♥ AJ	
	♦ AJ	
	♣ xx	
Either:		Or:
♠		♠
♥ KQ		♥ KQ
♦ KQ		♦ KQ
♣ KQ		♣ KQ
	♠ A (squeeze card)	
	♥ x	
	♦ x	
	♣ AJ10 (extended threat)	

When the spade is played, the squeeze, East or West, has no escape. A club discard gives declarer a two-trick gain at once, while unguarding one of the other threats results in a second squeeze when the established threat is cashed.

One of those North threats could be naked, and it would have been advisable to cash a North threat-protector earlier. In general, early cashing of unneeded protectors reduces the probability of an ambiguity problem.

C. North has all three threats

- North must have an entry in one of the threat suits.
- Always succeeds for one trick vs West, never vs East.
- Never repeats.

	♠ x	
	♥ AJ	
	♦ K	
	♣ K	
Either:		Or:
♠		♠
♥ KQ		♥ KQ
♦ A		♦ A
♣ A		♣ A
	♠ A (squeeze card)	
	♥ x	
	♦ x	
	♣ x	

No matter what West throws, declarer gains only one trick from the squeeze. East cannot be squeezed at all, easily discarding from whichever suit is played from the North hand. Although the squeeze against West would operate if North had a protector in another threat suit, that protector would not be needed and should be cashed earlier to avoid any ambiguity as to which suit West unguards.

A one-loser triple squeeze sometimes comes in handy when the required conditions for a simple squeeze are not achievable. Next-to-last F winner is the squeeze card:

	♠ x	
	♥ A3	
	♦ A32	
	♣	
♠ xx		♠
♥ 10		♥ KQJ
♦ J		♦ KQ
♣ xx		♣ A
	♠ AKQ	
	♥ xx	
	♦	
	♣ K	

The conditions are not right for any sort of simple squeeze of East in this notrump contract, but if East must guard all three suits he will be squeezed on the next-to-last spade winner. Let's assume East keeps the club ace. With North having only one idle card (two of diamonds) when the second spade is cashed, on the last spade declarer must discard the threat that East still has guarded, guessing which suit that is. (East might discard the diamond queen on the first round of spades, and the heart queen on the next round.)

If North has two idle cards, the squeeze will be squeezed twice before declarer must throw away a threat, so ambiguity is not a problem:

	♠	
	♥ AKQ10xx	
	♦ AJ	
	♣	
♠		♠
♥ xxx		♥ Jxxx
♦ xx		♦ KQ
♣ xxx		♣ KQ
	♠ AK	
	♥	
	♦ xxx	
	♣ AJx	

Declarer, on lead in the South hand, needs all the remaining tricks in a notrump grand slam. Thanks to the club protector, there are two idle hearts to discard on the last two spades, and East is pulverized by those cards. If South had a heart, the diamond ace could have been cashed earlier.

COMPOUND SQUEEZES

A compound squeeze begins with a triple squeeze against one opponent, followed by a double squeeze against both opponents, or possibly a simple squeeze against one opponent.

The requirements (not always sufficient) are:

- One loser remaining
- One single threat over the guarding defender ("basic threat")
- Two double threats, each accompanied by a protector-entry ("B threats")

One player must guard the basic threat as well as the two B threats, which can't be done. That player must unguard one of the B suits, whereupon the threat in that suit becomes a single threat, either an R threat or an L threat, guarded by partner. The stage is then set for a double squeeze. If the basic-threat holder unguards both B suits, partner is subject to a simple squeeze in those suits.

Note that threats described as "double threats" may be guarded by only one opponent when the other is short in the suit, and in fact may be guardable by only one opponent (e.g., AKxx opposite Qxx). Such hands should be played as if the threats were double threats, as the fact that they are really single threats doesn't matter.

In all compound squeezes, a time comes (the "fork") when declarer must decide which double threat has been unguarded by the first squeezee. In an "unrestricted" compound squeeze, the fork does not come until all F winners have been cashed. In a "restricted" version of the squeeze, the last F winner cannot be cashed until after the fork is taken, which may require some serious card reading (or guessing).

Type R Compound Squeeze

In this squeeze, both double threats are in the same hand, opposite a lonely basic threat. The basic threat becomes the R threat in an eventual type R double squeeze.

A. Unrestricted - Basic-threat hand has two protector-entries in threat suit(s), at least one of which is in the basic-threat suit.

- Fork comes after the last F winner.
- Ambiguity is rare; the suit abandoned by the basic threat holder becomes the L threat suit in a non-simultaneous type R double squeeze

There are two types of unrestricted type R compound squeezes: (1) The basic threat is accompanied by one protector only, or (2) the basic threat has two or more protectors.

(1) Basic threat hand has only one protector in the basic threat suit:

- The last F winner (squeeze card) can be in either hand.
- There must be a second threat protector-entry in the basic threat hand.

♠ AQ (F suit)
 ♥ Ax (B threat)
 ♦ Kxx (B threat)
 ♣

Lth Hand	Rth Hand
♠	♠
♥ KJx	♥ Qx
♦ J10xx	♦ Qxx
♣	♣ KQ

♠ KJ
 ♥ x
 ♦ Ax
 ♣ AJ (lonely basic threat)

Here the basic-threat hand's required second protector-entry is in a B threat suit. The last F winner may be in either hand, so the spades may be cashed in any order. The fork comes after the last F winner, so ambiguity is rare. It is almost always apparent which double-threat suit the basic threat guarder (East, above) abandons, which becomes the L suit for a double squeeze.. Declarer cashes the winner(s) in that suit first, being careful to end up in the correct hand, resulting in a type R non-simultaneous double squeeze. The basic threat holder is unlikely to unguard both double threats, resulting in a simple squeeze against partner.

There are three possible endings after the spades are played (ending in the South hand):

(I) East can discard one heart, provided that West discards no more than one, and one diamond, with the same provision. But now West is subjected to a simple type 1 (Sinister) squeeze in this five-card ending:

	♠	
	♥ Ax	
	♦ Kxx	
	♣	
Lth Hand		Rth Hand
♠		♠
♥ KJ		♥ Q
♦ J10x		♦ Qx
♣		♣ KQ
	♠	
	♥ x	
	♦ Ax	
	♣ AJ (now the F suit)	

When the club ace is played, West is squeezed. To avoid ambiguity, however, either the king-ace of diamonds (in that order) or the heart ace-diamond ace (in that order) should be cashed before the club ace. Otherwise declarer may not know for sure what to throw from the North hand when cashing the ace of clubs. Has West unguarded diamonds or hearts?

All compound squeezes end in such a simple squeeze when the basic-threat holder unguards both B threats. The remainder of this chapter will ignore such endings, which are covered in the chapter on simple squeezes.

(II) If East discards two diamonds, keeping a heart guard, an R-type double squeeze results, as this position is reached:

	♠	
	♥ Ax (B threat)	
	♦ Kxx (the L threat now)	
	♣	
Lth Hand		Rth Hand
♠		♠
♥ KJ		♥ Qx
♦ J10x		♦ Q
♣		♣ KQ
	♠	
	♥ x	
	♦ Ax	
	♣ AJ (R threat)	

Following the rule for R-type squeezes (last of the R and F winners must lie in the hand opposite the B threat), declarer cashes the diamond (L suit) king, then the diamond ace, squeezing East out of a heart, then the club ace, squeezing West.

(III) If East discards the two hearts, keeping a diamond guard, this position is reached:

	♠	
	♥ Ax (the L threat now)	
	♦ Kxx (B threat)	
	♣	
Lth Hand		Rth Hand
♠		♠
♥ KJ		♥
♦ J10x		♦ Qxx
♣		♣ KQ
	♠	
	♥ x	
	♦ Ax	
	♣ AJ (R threat)	

The heart (now the L suit) ace is cashed, squeezing East out of a diamond, then the South hand is entered with the diamond ace, followed by the club ace to squeeze West.

(2) The basic-threat hand's two required threat protectors are in the basic-threat suit

— The last F winner (squeeze card) can be in either hand, provided there is communication with the basic threat hand after it is cashed. Otherwise the last F winner must be in the basic threat hand.

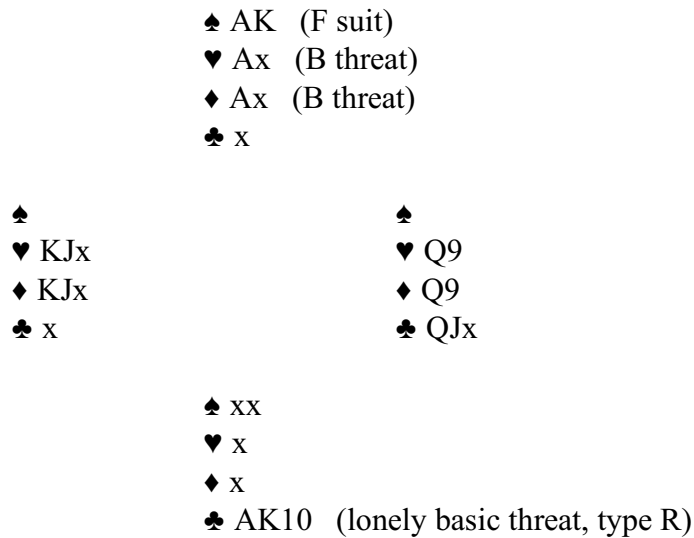

Here the basic-threat hand's two required protectors are in the basic threat suit. The basic-threat guarder (East) gets squeezed first, then the other opponent is squeezed by the basic-threat protectors. Again, declarer will cash the suit that East abandons (which becomes the L suit), resulting in a non-simultaneous type R double squeeze. The small club in the North hand provides the necessary communication to the basic-threat hand.

If East unguards clubs and hangs onto both red suits, the hand is over. Suppose, then, that East discards hearts on the two spades, making hearts the L suit for the upcoming double squeeze. The second spade is cashed, leading to this position:

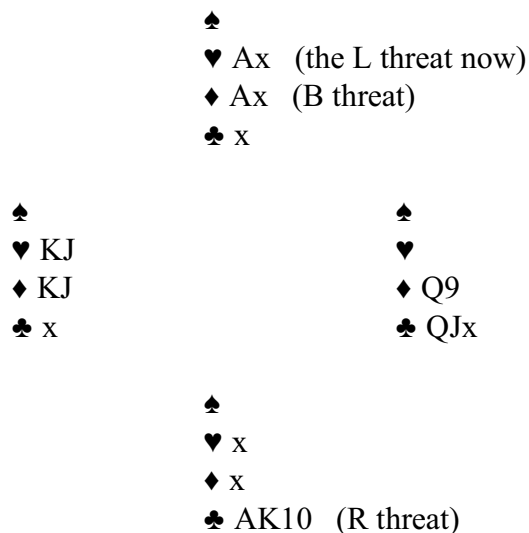

Now the ace of hearts (L suit) forces East to discard a diamond, following which the AK of clubs squeezes West.

If instead East discards two diamonds on the two spades, the same non-simultaneous double squeeze follows except that the red suits are switched, with the diamond ace (now the L suit) cashed first.

If the ace and king of spades had been split between the two hands, so that the South hand could play the last F winner, then the small club in the North hand would not have been required. The situation is this:

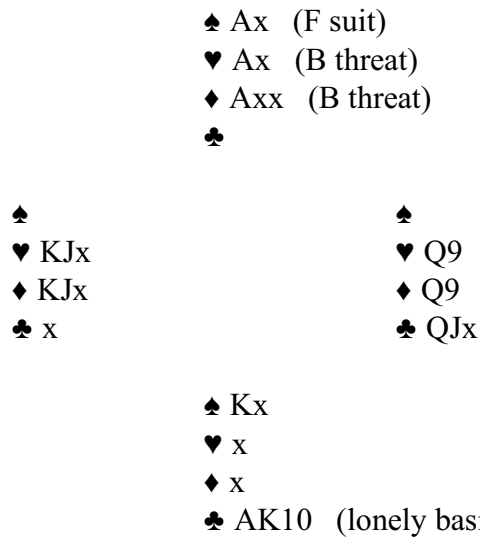

It is necessary, however, to cash the winner(s) in what becomes the L suit before exiting the North hand. Cash the ace of spades, which sets the stage for an R-type double squeeze. Cash ace of whichever red suit East unguards (now the L suit), reaching this position when East has unguarded hearts:

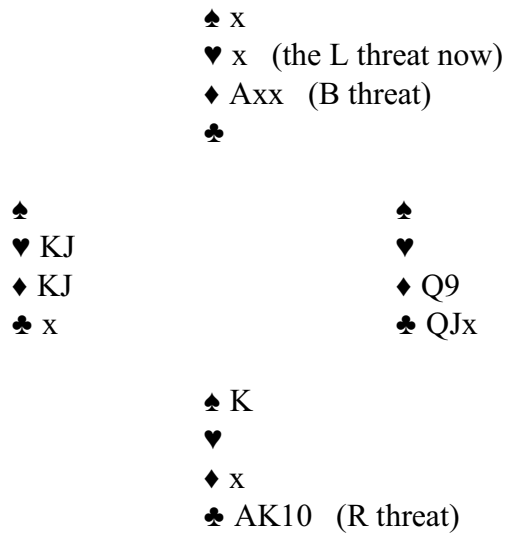

A spade is led to the king, squeezing East out of a diamond and West out of a heart. Then the ace-king of clubs squeezes West.

B. Restricted - Basic-threat hand has only one protector-entry

- Fork comes when next-to-last F winner is cashed.
- Which suit becomes L suit (suit abandoned by Rth hand) may be ambiguous.
- Last F winner (squeeze card) must lie in basic threat hand.
- Basic threat hand's entry may be in any suit.
- Requires crossing over to cash L-suit protector(s) in North hand and return to cash final squeeze card, so a return must be possible (in any suit).

	♠ x	
	♥ Ax (B threat)	
	♦ Ax (B threat)	
	♣ x	
Lth Hand		Rth Hand
♠		♠
♥ Q9x		♥ KJ
♦ Q9x		♦ KJ
♣		♣ KQ
	♠ AK (F suit)	
	♥ x	
	♦ x	
	♣ AJ (lonely basic threat)	

In this case the required entry to the basic-threat hand is in the basic-threat suit. The fork comes after the next-to-last spade winner, and ambiguity can be a problem: Which suit has East abandoned? After cashing the first spade (initial squeeze), declarer cashes the suit that East abandons (now the L suit), and must be able to return (in any suit) to cash the last F winner for a type-R simultaneous double squeeze.

Suppose East abandons diamonds on the next-to-last spade, resulting in this position:

	♠ x	
	♥ Ax (B threat)	
	♦ Ax (the L threat now)	
	♣ x	
Lth Hand		Rth Hand
♠		♠
♥ Q9		♥ KJ
♦ Q9x		♦ K
♣		♣ KQ
	♠ K	
	♥ x	
	♦ x	
	♣ AJ (R threat)	

Guessing the East has abandoned diamonds, not hearts, declarer cashes the ace of diamonds, comes to the ace of clubs, and leads the last spade for the easy double squeeze.

If declarer guesses wrong and cashes the ace of hearts first, this would be the position:

	♠ x	
	♥ x	
	♦ Ax	
	♣ x	
Lth Hand		Rth Hand
♠		♠
♥ Q		♥ K
♦ Q9x		♦ K
♣		♣ KQ
	♠ K	
	♥	
	♦ x	
	♣ AJ	

When the club is led to the ace and the king of spades cashed, West throws a diamond and the last heart, while East throws the diamond king. With East sitting over the unprotected heart threat, there is no squeeze.

If North's club were a small diamond, this would be the situation after the first spade is cashed:

	♠	
	♥ Ax (the L threat now)	
	♦ Axx (B threat)	
	♣	
Lth Hand		Rth Hand
♠		♠
♥ Q9		♥ K
♦ Q9x		♦ KJ
♣		♣ KQ
	♠ K	
	♥ x	
	♦ x	
	♣ AJ (R threat)	

West has abandoned hearts, but with no entry to the South hand it is not possible to cash the L threat protector before playing the last spade. No squeeze.

If the last spade is cashed now, West and North discarding a diamond, East merely throws the last heart, leaving this position:

	♠	
	♥ Ax (now the L threat)	
	♦ Ax (B threat)	
	♣	
Lth Hand		Rth Hand
♠		♠
♥ Q9		♥
♦ Q9		♦ KJ
♣		♣ KQ
	♠	
	♥ x	
	♦ x	
	♣ AJ (R threat)	

On the ace of clubs, West throws a diamond and declarer must lose a trick no matter what is thrown from the North hand.

If North had started with two spades, the necessary return capability would be present. Take a look:

	♠ xx	
	♥ Ax (B threat)	
	♦ Ax (B threat)	
	♣	
Lth Hand		Rth Hand
♠		♠
♥ Q9x		♥ KJ
♦ Q9x		♦ KJ
♣		♣ KQ
	♠ AK (F suit)	
	♥ x	
	♦ x	
	♣ AJ (lonely basic threat)	

The ace of spades is cashed, forcing East to unguard a red suit. The ace of that suit is cashed, and the second spade in the North hand provides an entry to the South hand, with the same variations as the preceding deals.

Also, the next-to-last spade trick could be won in the North hand (exchange king of spades and one of North's small spade).

If the return entry is a protector in the suit that becomes the L suit, declarer must first cash any protector that North has in that suit:

	♠ x	
	♥ Ax (B threat)	
	♦ Kxx (B threat)	
	♣	
Lth Hand		Rth Hand
♠		♠
♥ Qxx		♥ KJ
♦ J10x		♦ Qxx
♣		♣ A

♠ AK (F suit)
 ♥ x
 ♦ Ax
 ♣ K (lonely basic threat)

Declarer cashes the ♠A (which could be in the North hand, swapped with the small spade) for the initial squeeze on East.

Here is the position if East abandons hearts when the first spade is led:

	♠	
	♥ Ax (the L threat now)	
	♦ Kxx (B threat)	
	♣	
Lth Hand		Rth Hand
♠		♠
♥ Qx		♥ K
♦ J10x		♦ Qxx
♣		♣ A

♠ K
 ♥ x
 ♦ Ax
 ♣ K (R threat)

The sequence is now ace of hearts, diamond ace, and spade king for an easy double squeeze.

Suppose East abandons diamonds instead, reaching this position:

	♠	
	♥ Ax (B threat)	
	♦ Kxx (the L threat now)	
	♣	
Lth Hand		Rth Hand
♠		♠
♥ Qxx		♥ KJ
♦ J10x		♦ Qx
♣		♣ A
	♠ K	
	♥ x	
	♦ Ax	
	♣ K (R threat)	

The top cards in the abandoned diamond suit are cashed first, but the diamond king must be cashed before the diamond ace, or the squeeze fails. This is in accordance with the rule for type R double squeezes: Cash L protector(s) in the North hand first!

The required return entry for cashing the last free winner in the South hand may be in the F suit if the basic threat is protected:

	♠ Ax	
	♥ Ax (B threat)	
	♦ Ax (B threat)	
	♣	
Lth Hand		Rth Hand
♠		♠
♥ Q9x		♥ KJ
♦ J10x		♦ Qx
♣		♣ KQ
	♠ Kx (F suit)	
	♥ xx	
	♦ x	
	♣ AJ (lonely basic threat)	

The ace of spades is cashed, and East unguards a red suit. After cashing the ace of that suit, declarer returns to the South hand via the king of spades, which squeezes East in clubs and the red suit East has kept. Assuming East keeps clubs guarded, the ace of clubs squeezes West in the red suits.

Type L Compound Squeeze

In this squeeze the basic threat is not lonely, since a double threat is held in each hand. The basic threat becomes the L threat for an eventual type R or type B2 double squeeze.

A. **Unrestricted** - The lonely double threat is headed by two protectors

	♠ KJ (F suit)	
	♥ K (basic threat)	
	♦ xx	
	♣ Ax (B threat)	
Lth Hand		Rth Hand
♠		♠
♥ A		♥ x
♦ Q9x		♦ J10x
♣ KJx		♣ Q10x
	♠ AQ (F suit)	
	♥ x	
	♦ AKx (lonely double threat)	
	♣ x	

Since the last F winner may be in either hand, declarer can cash the spades in either order. The fork comes after the last F winner is cashed, which means that ambiguity about which suit West abandons is very unlikely. If North has "extra" protectors in any of the threat suits, cashing them early will lessen the chance of any ambiguity.

Conditions for both a type R or type B2 double squeeze must be present when the last F is played, with the basic threat as the L threat in either case. Which type eventuates is determined by West's discard on the next-to-last winner. West cannot discard a club and a diamond, as that would subject East to a simple squeeze in the minor suits.

Suppose West abandons diamonds, leaving East to guard them. The position is:

	♠ J	
	♥ K (the L threat now)	
	♦ x	
	♣ Ax (B threat)	
Lth Hand		Rth Hand
♠		♠
♥ A		♥
♦ Q9		♦ J10x
♣ KJ		♣ Q10
	♠ A	
	♥	
	♦ AKx (the R threat now)	
	♣ x	

Diamonds has become the R suit for a type R double squeeze. The ace of spades forces another diamond from West, and East must throw a club. Cashing the suit that was abandoned, diamonds, the AK of diamonds now squeezes West.

If West had abandoned clubs instead, this would be the position:

	♠ J	
	♥ K (the L threat now)	
	♦ x	
	♣ Ax (the R threat now)	
Lth Hand		Rth Hand
♠		♠
♥ A		♥
♦ Q98		♦ J10x
♣ K		♣ Q10
	♠ A	
	♥	
	♦ AKx (now the B threat)	
	♣ x	

The situation is now a B2 double squeeze. After cashing the last spade, West throwing a club and East a diamond, declarer leads to the ace of clubs (the suit abandoned by West) to complete the squeeze.

Defenders: Convert the unrestricted type squeeze to the more difficult restricted type by attacking protectors in the lonely threat suit.

B. Restricted - The lonely double threat (B threat) is headed by just one protector.

- Fork comes after next-to-last F winner.
- Which suit is "R" (abandoned by West) may be ambiguous.
- Conditions for either a type R or B1 double squeeze (depending on which suit the Lth hand abandons) must be present when the last winner is played.
- Both hands need two entries in different threat suits
- The last F-suit winner must be in the lonely-threat hand.

In this deal, both hands have an entry in the basic-threat suit, in addition to the required entry-protector in a B-threat suit:

	♠ x	
	♥ Ax (B threat)	
	♦ x	
	♣ Kxx (basic threat)	
Lth Hand		Rth Hand
♠		♠
♥ KJ		♥ Qxxx
♦ KJ		♦ Q10x
♣ QJ10		♣

♠ AK (F suit)
 ♥ x
 ♦ Ax (lonely B threat)
 ♣ Ax

The lonely double-threat suit (diamonds) is headed by only one protector. The initial squeeze occurs on the next-to-last spade, producing a fork: Declarer must know (or guess) which red suit West abandons. He cashes North's protector(s) in that suit and then cashes the last spade, finishing off the squeeze.

If West has unguarded North's B threat in hearts, the position is this:

	♠	
	♥ Ax (now the R threat)	
	♦ x	
	♣ Kxx (the L threat now)	
Lth Hand		Rth Hand
♠		♠
♥ K		♥ Qxx
♦ KJ		♦ Q10x
♣ QJ10		♣

♠ K
 ♥ x
 ♦ Ax (B threat)
 ♣ Ax

Declarer cashes the protector(s) in that suit (ace of hearts) and must have a return entry to the South hand. In this case the required entry is in the basic threat (now the L threat) suit, clubs. West's discard has made hearts the R suit for a type B1 restricted-type double squeeze, dictating the order of last R, last F, and last L for cashing of winners. So, declarer cashes the heart ace (R), club ace, spade king (F), squeezing West, then the club king (L), squeezing East.

If West has unguarded South's B threat in diamonds, the position is this:

	♠	
	♥ Ax (B threat)	
	♦ x	
	♣ Kxx (the L threat now)	
Lth Hand		Rth Hand
♠		♠
♥ KJ		♥ Qxx
♦ K		♦ Q10x
♣ QJ10		♣
	♠ K	
	♥ x	
	♦ Ax (the R threat now)	
	♣ Ax	

Diamonds has become the R-threat suit for a type R double squeeze, for which the rule is to first cash L protector(s) in the North hand. Declarer cashes the club tops and diamond ace (any order, but ending in the South hand), then the last spade for the double squeeze. (The diamond ace could be cashed after the last spade, merely making the squeeze non-simultaneous instead of simultaneous.)

In any case declarer discards the basic threat on the squeeze trick when West refuses to unguard it.

Here is an example of what happens when one hand lacks the required two entries, in this case the North hand:

	♠ x	
	♥ Kxx (B threat)	
	♦ x	
	♣ K (basic threat)	
Lth Hand		Rth Hand
♠		♠
♥ Q109		♥ Jxx
♦ KJ		♦ Q10x
♣ A		♣
	♠ AK (F suit)	
	♥ Ax	
	♦ Ax (lonely B threat)	
	♣	

South cashes the ace of spades. If West pitches a diamond, the situation turns into a type R double squeeze. South can cash the ace of diamonds (or not, but it's prettier to do so), then execute the double squeeze by cashing the last spade.

If West pitches a heart, there is no squeeze. What happened? The answer is that the necessary conditions for a type B1 double squeeze are not present, because North has only one entry in a threat suit. If South continues with the king of spades, dummy is squeezed in front of East.

Let's try it with a second entry, this time in the basic threat suit:

	♠ x	
	♥ Kxx (B threat)	
	♦ x	
	♣ AJ (basic threat)	
Lth Hand		Rth Hand
♠		♠
♥ Q109		♥ Jxx
♦ KJ		♦ Q10x
♣ KQ		♣ x
	♠ AK	
	♥ Ax	
	♦ Ax (lonely B threat)	
	♣ x	

Now when West pitches a heart on the first spade, this is the situation:

	♠	
	♥ Kxx (the R threat now)	
	♦ x	
	♣ AJ (L threat)	
Lth Hand		Rth Hand
♠		♠
♥ Q10		♥ Jxx
♦ KJ		♦ Q10
♣ KQ		♣ x
	♠ K	
	♥ Ax	
	♦ Ax (B threat)	
	♣ x	

We now have a B1 restricted-type RFL double squeeze. Declarer first cashes king of hearts, ace of hearts (last R), last spade (F), squeezing West, and the ace of clubs (last L), squeezing East. Of course the heart tricks must be cashed in the right order, ending in the hand with the F suit.

If North has an entry-protector in both of the double-threat suits, the basic threat need not be accompanied by a protector because the type B1 double squeeze that may develop is of the unrestricted type, not the restricted "RFL" type:

	♠ x	
	♥ Ax (B-threat)	
	♦ Kx	
	♣ Qx (basic threat)	
Lth Hand		Rth Hand
♠		♠
♥ KJ		♥ Q109
♦ Q10x		♦ J9xx
♣ Kx		♣
	♠ AK	
	♥ x	
	♦ Axx (lonely B-threat)	
	♣ A	

West can choose between two poisons when declarer plays a spade: either a type B1 unrestricted double squeeze (heart discard) or a type R double squeeze (diamond discard). In this case one of the two required entries is in the basic threat suit.

Let's say West lets go of a heart, resulting in this position:

	♠	
	♥ Ax (B threat)	
	♦ Kx	
	♣ Qx (basic threat)	
Lth Hand		Rth Hand
♠		♠
♥ K		♥ Q109
♦ Q10x		♦ J9x
♣ Kx		♣
	♠ K	
	♥ x	
	♦ Axx (lonely B threat)	
	♣ A	

This is a B1 unrestricted-type double squeeze. Cash the R (heart) winner first in accordance with the rule for doing so, then ace of clubs (a necessary entry), and finally the last spade for a simultaneous double squeeze. West must guard clubs, East must guard hearts, no one can guard diamonds.

If West lets go of a diamond, this is the situation:

	♠	
	♥ Ax (B threat)	
	♦ Kx	
	♣ Qx (L threat)	
Rth Hand		Lth Hand
♠		♠
♥ KJ		♥ Q109
♦ Q10		♦ J9x
♣ Kx		♣
	♠ K	
	♥ x	
	♦ Axx (the R threat now)	
	♣ A	

The club ace isn't a necessary entry in this case, and can be cashed right away. (Always cash unneeded winners early.) We now have an easy type R double squeeze. Cash the king of diamonds, ace of diamonds, then the last spade. West must guard clubs, East must guard diamonds, no one can guard hearts.

Alternative Threat Compound Squeeze

This squeeze looks like a type L compound squeeze (double threat in each hand, basic threat not lonely). However, the double threats are such that the defender holding the basic threat can foil the squeeze with proper discarding. If that happens, and there are alternative double threats in a threat suit, one in each hand, declarer can sometimes use an alternative threat to develop an alternative type R double squeeze. This alternative squeeze requires:

- A basic threat that is accompanied by at least one protector
- (1) Opposite the basic threat a double threat that has an entry in each hand, or
- (2) The basic threat has at least two protectors, with a small card opposite
- A double threat in the basic threat hand that has a minimum of protector-and-small opposite two small.

(1)		♠ x ♥ A7 (B threat) ♦ AJ (basic threat) ♣ K5
	Lth Hand	Rth Hand
	♠ ♥ KJ ♦ KQ ♣ Q109	♠ ♥ Q109 ♦ 2 ♣ J93
		♠ AK (F suit) ♥ 32 (alternative B threat) ♦ ♣ A87 (B threat)

This looks like a restricted type L compound squeeze, leading to a type B1 or type R double squeeze with the heart 7 as the B threat, but the requirement that each hand have two entries in different threat suits is not met, as the South hand has only one such . That squeeze works if the Lth hand abandons clubs on the first spade, reaching this position:

		♠ ♥ A7 (B threat) ♦ AJ (basic threat) ♣ K5
	Lth Hand	Rth Hand
	♠ ♥ KJ ♦ KQ ♣ Q10	♠ ♥ Q10 ♦ 2 ♣ J93
		♠ K (F suit) ♥ 32 ♦ ♣ A87 (now the R threat)

A type R double squeeze position has been reached, in which the last non-B winner must come from the R-threat hand, so declarer goes to the club king, cashes the diamond ace (advisable, but not necessary), returns to the club ace, and plays the last spade for a type R double squeeze, with the club 8 the R threat and the heart 7 the B threat.

But what if the Lth hand abandons hearts, leading to this position?

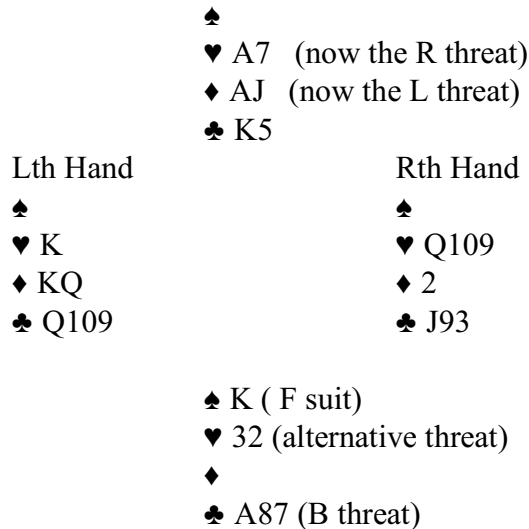

The double squeeze is then an unrestricted type B1, in which the last R protector must precede the last F winner. The club 8 is now the B threat, and the R suit is now hearts, but there is no way to play off the heart ace without destroying the squeeze position.

However, in this diagram the heart 3 is an alternative threat. The basic threat protector is needed to provide room in the South hand for the alternative threat, which now comes into play.

The last spade is cashed and the former heart 7 threat is discarded, reaching this position:

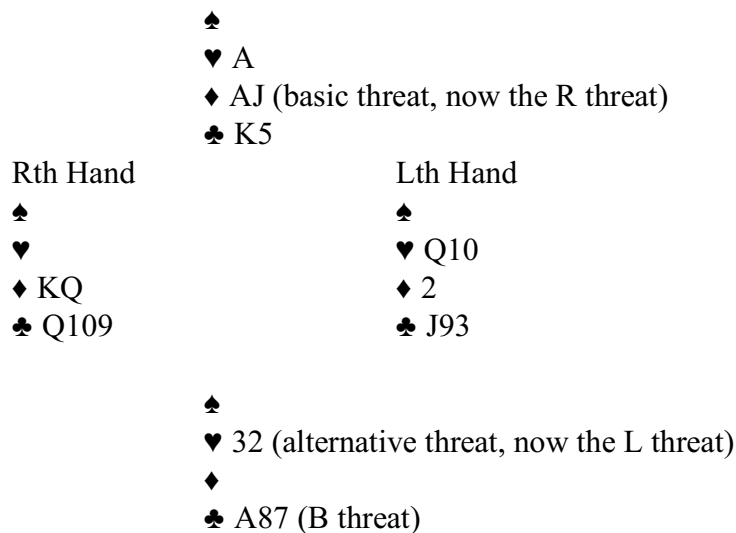

Note that the Rth and Lth hands are now different. A heart is led to the ace, squeezing the Rth hand, and the diamond ace squeezes the Lth hand, in a non-simultaneous type R double squeeze.

Note that the final F winner must be played off before going over to the North hand, as the last of the non-B winners must be led from the R-threat hand in a type R double squeeze.

(2) When there is no double threat with an entry in each hand, an extra protector in the basic threat suit, with a small card opposite for communication, provides compensation:

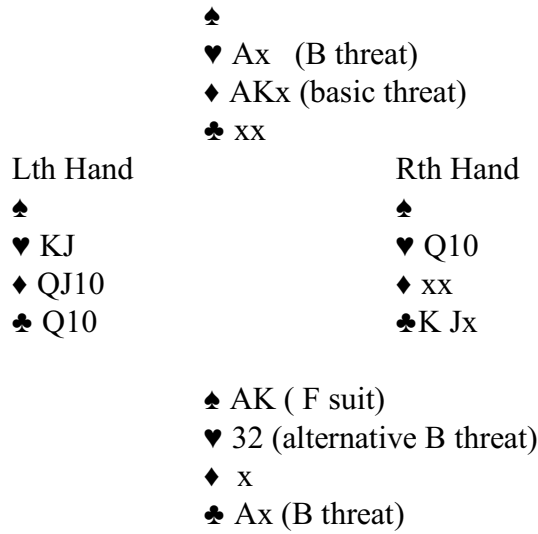

When the first F winner is cashed, West must unguard a minor suit. If he abandons clubs, declarer must not cash the last F winner, which would squeeze dummy. Instead, he must cash the AK of diamonds and return to his hand with a club, reaching this double-squeeze position:

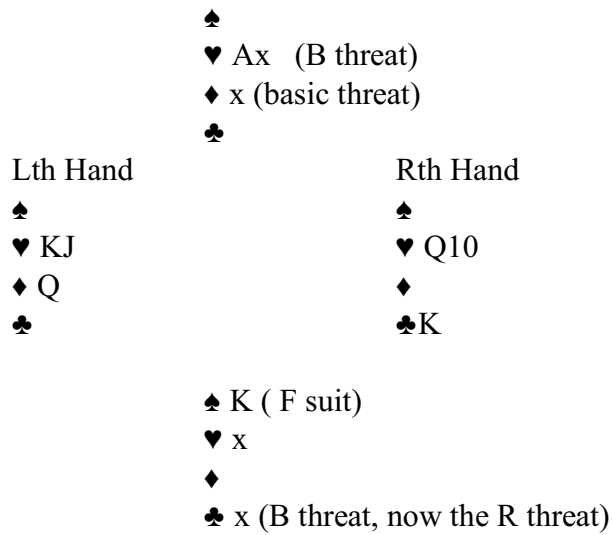

When the last spade is cashed, declarer must take the rest.

If instead West abandons hearts, the alternative threat comes into play in this position:

	♠	
	♥ Ax (B threat)	
	♦ AKx (basic threat)	
	♣ x	
Lth Hand		Rth Hand
♠		♠
♥ K		♥ Q109
♦ QJ10		♦
♣ Q10		♣ K Jx
	♠ K (F suit)	
	♥ 32 (alternative B threat)	
	♦ x	
	♣ Ax (B threat)	

Declarer cashes the last spade, West throws a heart, and the small heart must be played from dummy, making South's small heart the threat. A heart to the ace then squeezes West out of a club, after which East is squeezed in hearts and clubs when dummy's high cards are cashed.

The basic rule for all compound squeezes:

FIRST CASH WINNERS IN THE SUIT ABANDONED BY THE BASIC THREAT GUARDER, ENDING IN THE HAND WITH THE FINAL SQUEEZE CARD!

Defenders: Attack protectors in the basic-threat hand, maybe cutting communication, maybe changing the squeeze from an unrestricted type to the more difficult restricted type. A good opportunity for disrupting declarer's communication arises when there is a singleton in dummy, or likely singleton in declarer's hand. Leading that suit will deny declarer any communication in that suit.

As in all potential squeeze positions, if you have to unguard a suit, do it early, before discarding unneeded cards. Declarer may think you have done just the opposite and lose the squeeze. As you become familiar with the various squeeze positions, you will come to know (when it matters) which suit you can safely unguard, leaving partner with the guard responsibility.

Defenders must watch out for the situation in which it may be wrong to follow the general rule of unguarding a threat held on the left when partner can guard it, and that is when RHO holds a threat in the suit also. The result is that partner is guarding a threat held on the left, which is undesirable.

KNOCKOUT SQUEEZES

This is a squeeze against an opponent's trump(s), when you can't afford to draw trumps. The opposing trump(s) may include a high trump. The squeeze involves ruffing in the long trump hand in dummy reversal fashion (although the reversal is not usually complete). Since the opponent must ruff to avoid unguarding threats, it's a way to pull trumps without leading trumps. Often the idea is to put pressure on opponents by making them play second hand in front of a squeezing trump instead of leading it and letting them play fourth hand. A number of preparatory ruffs may be necessary to reach the desired position:

	♠ KQ6
	♥ A104
	♦ A764
	♣ Q53
♠ 7	♠ J105
♥ 986	♥ KQJ5
♦ Q10852	♦ K93
♣ J984	♣ A102
	♠ A98432
	♥ 732
	♦ J
	♣ K76

After East opens the bidding with a 13-15 HCP one notrump, West leads the heart nine against South's 4♠ contract. The lead is ducked, and the suit continued. With trumps 2-2, South could ruff out diamonds and throw East in with the third heart, but trumps are not 2-2.

The answer is to ruff out diamonds anyway (after leading to the king of clubs), using the KQ of trumps as entries, arriving at this position:

	♠ 6
	♥ 10
	♦ 7
	♣ Q5
♠	♠ J
♥	♥ KQ
♦ Q10	♦
♣ J98	♣ A10
	♠ A9
	♥ 7
	♦
	♣ 76

East must commit when the last diamond is led, but any discard, including the ♠J, gives South the contract. The heart duck was not necessary in this case; despite the three losers, as East has no exit card after the diamonds are ruffed out. It is usually best, however, to rectify the count for a knockout squeeze in the same way as for any other squeeze. When anticipating a strip squeeze ending, as above, declarer normally tries to duck down to two losers. In this case more losers are okay because East has no “out-card.”

The knockout squeeze can work even when the squeezees has a high trump:

	♠ Q92	
	♥ K763	
	♦ J4	
	♣ K852	
♠ 53		♠ A64
♥ 1052		♥ J984
♦ 9652		♦ AKQ8
♣ J1097		♣ Q4
	♠ KJ1087	
	♥ AQ	
	♦ 1073	
	♣ A63	

After a club lead against a four spade contract by South, declarer cashes the heart AQ, enters dummy with the club king, discards a club on the heart king, and ruffs a club, hoping for 3-3 clubs. Declarer then leads a diamond, and East must lead trumps to prevent a diamond ruff. South then ruffs the fourth club and East is squeezed in three suits, including trumps (whether or not he has cashed the spade ace). This is the end position, with the club about to be led:

	♠ Q2	
	♥ 7	
	♦ J	
	♣ 8	
♠ 5		♠ A6
♥		♥ J
♦ 965		♦ AK
♣ J		♣
	♠ KJ10	
	♥	
	♦ 107	
	♣	

If East had played ace and another spade, the squeeze would still have worked. Note that the East and West hands could be switched and the squeeze would still operate.

Entry shifting (i.e., ruffing high or low) on the last ruffing trick may be involved in a knockout, in which case only second hand (or third) can be squeezed. Otherwise the knockout works against either opponent.

Defenders: Lead trumps early!

BACKWASH SQUEEZES

This squeeze is an antipositional knockout squeeze. The squeezee's trump holding is "caught in the backwash." It is a way to make a defender's undrawable trump(s) useless. It involves ruffing a card (often a winner) with a high trump in front of the squeezee. Frequently a dummy reversal (perhaps not complete) is involved, and sometimes declarer's high ruff establishes a trump trick for the defender.

	♠ A (trump suit)	
	♥	
	♦ K	
	♣ K	
♠		♠ Q
♥KQJ		♥
♦		♦ A
♣		♣ A
	♠ K	
	♥ Ax	
	♦	
	♣	

South, on lead, ruffs the losing heart with the spade ace. If West held East's cards the squeeze would be an ordinary knockout squeeze. The backwash squeeze may involve giving up a trump trick in order to gain two tricks:

	♠ KQ9	
	♥ AKxxx	
	♦ xx	
	♣ xxx	
♠ 8xxx		♠ A
♥ xx		♥ QJ10x
♦ Jxxx		♦ Kxxx
♣ xxx		♣ KQJx
	♠ J10xxx	
	♥ xx	
	♦ AQ10	
	♣ Axx	

(East opened 2♦, showing a 4-4-4-1 hand that the bidding revealed was specifically 1=4=4=4.)

Playing in four spades, South gets a low diamond lead to the king and ace. There follows a spade to the ace, club shift, ducked, and club continuation to the ace. Declarer plays the high hearts, ruffs a heart high, leads a spade to dummy, ruffs another heart high, squeezing West out of the club exit (underruffing permits

declarer to pull trumps with North's last spade). Now the last spade is led to dummy and a club discard on the last heart endplays West when he ruffs.

Sometimes declarer even ruffs a high card with a high trump, resulting in a Vienna Coup backwash squeeze. Declarer gets the trick back with interest, however:

	♠ K (trump suit)	
	♥	
	♦ QJ109	
	♣ AK10	
♠		♠ QJ
♥		♥ x
♦		♦ AK
♣		♣ QJx
	♠ A2	
	♥ AK	
	♦	
	♣ 9xxx	

With no way to draw trumps, declarer plays the heart ace (throwing the diamond nine, not the club ten!) and ruffs the heart king, establishing a trump trick for East. But what does East play? No discard, not even a spade, succeeds.

While not exactly a squeeze, and the last ruff is not with a high trump, the following deal (misplayed by the author) is an example of the backwash technique:

	♠ K82	
	♥ Q97	
	♦ AQJ32	
	♣ Q2	
♠ 1073		♠ QJ965
♥ AK843		♥
♦ 98		♦ 10765
♣ 1076	♣ AJ98	
	♠ A4	
	♥ J10652	
	♦ K4	
	♣ K543	

West leads the spade three against South's four heart contract. Declarer wins the spade ace and leads a heart to the queen (ugh!). Declarer then knocks out the club ace, ruffs a spade in hand and a club in dummy. Then comes the diamond ace, diamond king, and the last club is ruffed, West "discarding" a low heart. Now a diamond is ruffed high by South (promoting the heart eight), and West is caught in the "backwash," endplayed in the trump suit if he overruffs. A squeeze in one suit!

Look for a backwash squeeze when:

- There is no way to establish a suit, draw trumps, and cash the established card(s); and/or
- The trump suit is blocked in such a way that trumps can only be drawn by a trump coup, end play, or smother play (executed after the backwash squeeze is complete).

ENTRY SQUEEZES

This is a two-suit or three-suit squeeze, but in one of the suits the defender has no potential winner. The card(s) in that suit are merely good enough to deny declarer a needed entry or reentry, being of higher rank than the potential entry card.

Declarer must be alert to the possible need for unblocking (e.g., playing 7 from K72 opposite AQ6, making the 6 a third round entry if the opponent cannot hold on to, say, 98x).

	♠ 10643	
	♥ J1052	
	♦ 107	
	♣ AQ6	
♠ Q9872		♠ J
♥ 9843		♥ K76
♦ 82		♦ K953
♣ 107		♣ 98532
	♠ AK5	
	♥ AQ	
	♦ AQJ64	
	♣ KJ4	

West psychs a one spade opening, and South ends up in 6NT. West leads a spade, South wins, plays another high spade, and leads toward the spade ten. West wins and exits with the ten of clubs. South, wanting three club entries, plays the club ace and club king on the same trick (or club queen and club jack), finesses in hearts, cashes the heart ace, and overtakes South's high club, establishing East's nine. The spade ten then squeezes East in three suits, a club discard permitting the six of clubs to be an entry (and second squeeze card).

More often the squeeze is in two suits only:

	♠ A10	
	♥ A	
	♦	
	♣ 1043	
(Immaterial)		
♠		♠ QJ
♥		♥
♦		♦
♣		♣ K987
	♠ K9	
	♥	
	♦	

♣ AQJ2

South has the lead and no apparent losers in a notrump contract, but after cashing the high spades, the heart ace squeezes the South hand. The problem is neatly solved by overtaking the spade king with the ace! The lead of the heart ace then squeezes East into submission, because a spade discard permits the spade ten to become an entry, and a club discard enables that suit to run.

This is a fairly common position that is seldom handled correctly. Watch for it! You must see the self-squeeze coming before it is too late to do anything about it. Another example:

	♠ Q	
	♥	
	♦ 1032	
	♣ AKQ	
♠ J10986		♠ K7
♥		♥
♦ 65		♦ K987
♣		♣ 3
	♠ A2	
	♥	
	♦ AQJ2	
	♣ 2	

South is on lead and needs all the tricks. The ace of spades must be thrown on the second round of clubs, so that the queen of spades is an entry to dummy if East throws spades and keeps four diamonds. If East throws a diamond on the last club, then of course South throws the spade deuce and takes four diamond tricks.

ENTRY-SHIFTING SQUEEZES

Trump Entry-Shifting Squeezes

Look for this squeeze when a cross-ruff just won't bring in enough tricks, usually because of an outstanding trump, and there are ruffing threats against one opponent in two suits. The trick that is lost by leading a round of trumps instead of cross-ruffing comes back, sometimes with interest. (The "loser count" in the following examples includes that extra loser created by leading the round of trumps.)

The requirements for the squeeze are:

- The trump length in each hand must usually be equal (2-2, 3-3, etc.). One or more ruffs may be necessary to achieve the proper trump division, and declarer may have to postpone (or forego altogether) a ruffing finesse that results in an improper trump division.
- Declarer must be able to switch a trump winner to either hand after the trump is led (i.e., by overtaking or not). Early unblocking may be necessary to obtain the correct trump matrix for shifting the lead, which requires that a winner can be overtaken or not.
- The squeeze must be playing second (or third) hand to the squeeze trick.
- Fourth hand cannot be squeezed this way, because declarer must see the squeeze's discard before deciding where to win the trump trick.

Balanced Trump Holding

	♠ Qx (trump suit)	
	♥ Qx	
	♦	
	♣	
♠ J		♠
♥		♥ AK
♦ xxx		♦ AK
♣		♣
	♠ K10	
	♥	
	♦ Qx	
	♣	

The lead is in the North hand. A cross-ruff won't work because West can overruff the spade ten. That leaves declarer a trick short after drawing a round of trumps. When the spade queen is led, however, East must unguard a red suit. Declarer wins the trick in the hand holding the suit that East discards, and ruffs out East's remaining guard. This is a one-loser squeeze, so the trump length must be the same in both hands, and the loser count rectified earlier if necessary.

Declarer unblocked (and avoided an overruff) by using South's ace of spades earlier in the play, when ruffing a heart to equalize the trump holdings. Failure to ruff that heart would have spoiled the squeeze. Note that the loser count must be one for this squeeze.

For a two-suit squeeze without the count, and no throw-in element, an unbalanced trump holding is necessary. When declarer plans a two-suit, two-loser squeeze (e.g., a strip squeeze) with a throw-in element, the trumps must be balanced if both threats are minor tenaces:

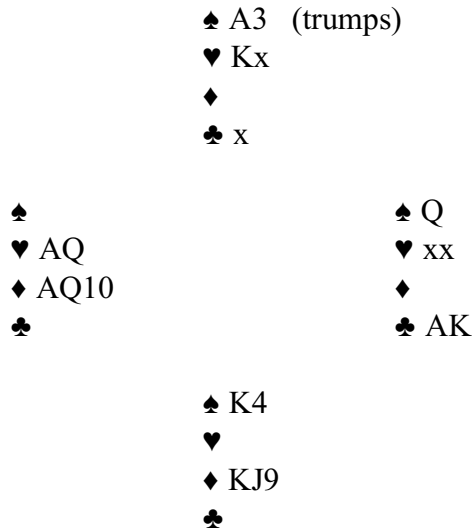

A cross-ruff is out, but the spade king leaves West helpless, declarer overtaking or ducking according to West's discard. If West discards a diamond, South will of course not overtake the king, and will then let West win a diamond, not ruffing. Note that when the spade king is led, declarer has two losers.

There is a squeeze that resembles an Entry-Shifting squeeze in that the trump holdings must be balanced and an opponent can choose which suit will be ruffed out.

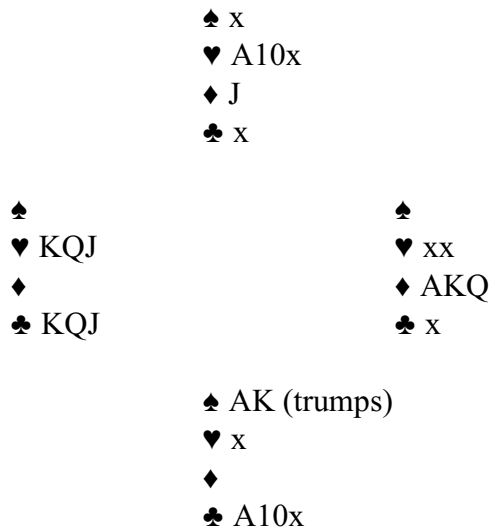

With the lead in the North hand, declarer must ruff a diamond, not lead a trump, in order to effect a squeeze on West and take all the tricks. This type of squeeze, which Terence Reese calls a Scissor Squeeze, is easy

to miss, as the preparatory ruff seems to have no purpose. Its purpose is to save that trump in dummy for use after the squeeze is effected.

Unbalanced Trump Holding

When there are two threats and one is a minor tenace, the trump matrix must be unbalanced for a "squeeze without the count":

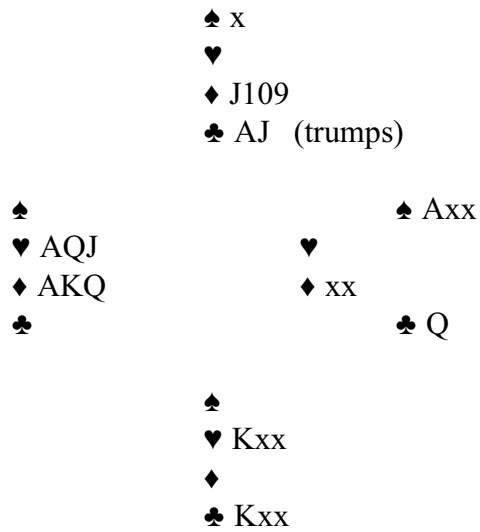

With clubs trump, the club queen prevents a cross-ruff, so declarer leads the club king, squeezing West. If West throws a diamond, declarer overtakes and leads a diamond on which a heart loser is sluffed, endplaying West. If West throws a heart, declarer plays low on club king and ruffs a heart, eventually establishing the third heart. If declarer had ruffed a spade earlier, balancing trumps, the entry-shifting squeeze would not work. Note the two losers when the club king is led, and that declarer has a minor tenace in one suit only (hearts).

The other type of entry-shifting trump squeeze requiring an unbalanced trump matrix occurs when declarer has threats in three suits, none of them a minor threat, against one defender. The long trump hand must contain an extended threat headed by a winner, and the short trump hand must have two extended threats, with or without winners, guarded by the squeeze. The classic version of the squeeze gains two tricks (not in progressive fashion, but *immediately*), to make up for the trick lost by not cross-ruffing:

	♠ Kx (trumps)	
	♥	
	♦ Qxx	
	♣ Qxx	
♠ Q		♠
♥ J10x		♥ KQxx
♦ Jx		♦ AK
♣ Jx		♣ AK
	♠ Axx	
	♥ Axxxx	
	♦	
	♣	

Declarer leads North's spade king, and East is squeezed out of two tricks. One cross-ruff trick has been exchanged for the two tricks gained by the squeeze. Note there are three losers when the spade king is led. If only two of the threats were extended, the squeeze wouldn't gain two tricks.

The unbalanced trump requirement for a three-suit squeeze does not apply if declarer's threats include an endplay element. In that case the trumps must be balanced:

	♠ AQ (trumps)	
	♥ x	
	♦	
	♣ KJx	
♠		♠ 2
♥ Kx		♥ Jxxx
♦ AQ		♦
♣ AQ		♣ x
	♠ Kx	
	♥ Q	
	♦ Kxx	
	♣	

The spade king squeezes West in three suits, giving South all but one trick. The endplay element comes into play if West's discard is a low heart, whereupon declarer keeps the lead in the South hand and leads the heart queen. If declarer had not ruffed a club in the South hand earlier, balancing the trumps, the squeeze would not work. Leading the spade king ups the loser count to three, but the squeeze gains two tricks for a net profit.

Except for 2-1 trumps (when the doubleton must lie over the squeeze) the longer trump length may be on either side of the squeeze provided a "flexible trump" led through the squeeze may be overtaken or not. Switch the East-West hands and the high spades in the last deal, and the squeeze still works:

	♠ Ax	
	♥	
	♦ Qxx	
	♣ Qxx	
♠		♠ Q
♥ KQxx		♥ J10x
♦ AK		♦ Jx
♣ AK		♣ Jx
	♠ Kxx	
	♥ Axxxx	
	♦	
	♣	

South leads the spade king and West is in the same fix that East was in the preceding deal.

One of the squeeze's guards against an extended threat may be a single card that is not what we normally consider a guard (although it is one):

	♠ 97 (trumps)	
	♥	
	♦ Q763	
	♣ Q109	
♠ 6		♠
♥ J96		♥ KQ108
♦ J8		♦ 1095
♣ K73	♣ J8	
	♠ K108	
	♥ A75432	
	♦	
	♣	

Declarer needs all but one trick in a spade contract, but unfortunately the lead is in the North hand and the hearts cannot be established. However, the spade nine squeezes East, who has multiple guards in the red suits plus the club eight, which prevents the establishment of two club tricks with one lead and therefore acts as a guard. There are three losers when the spade nine is led, but the squeeze gains two tricks, more than making up for the cross-ruff trick that was sacrificed.

When the squeeze has a single threat guard that protects partner's guard from being ruffed out, the long side suit in the long trump hand need not be headed by a winner, but the squeeze gains only one trick and there are two losers when the squeeze card is led:

	♠ Ax	
	♥	
	♦ Qx	
	♣ QJ	
♠		♠ Q
♥ AKQ		♥
♦ AK		♦ xx
♣ A		♣ Kxx
	♠ Kxx	
	♥ xxx	
	♦	
	♣	

Spades are trumps and the lead is in the South hand. A cross-ruff won't work because of the spade queen, but the spade king squeezes West. A club discard permits East's king to be ruffed out.

Notrump Entry-Shifting Squeezes

Look for an entry-shifting squeeze at notrump when there are two losers and a simple squeeze cannot be arranged. Declarer must have in each hand a CLA threat, both against the same defender, headed by a protector. This is actually a Strip and Duck squeeze, with the complication that the F-suit winners must be managed to provide the "L" (lead) for whichever threat is unguarded by the squeezee.

The remaining cards in the F suit must be distributed 2-2, and the distribution of strength in that suit (the "matrix") must be appropriate to the particular position. Declarer must get rid of any F-suit cards that interfere with achievement of the proper matrix, by cashing, unblocking, and/or finessing as necessary to achieve that end.

There are two basic positions for notrump entry-shifting squeezes, depending on the entry situation for the two CLA threats involved.

A. Each hand has a small card in the protected CLA threat suit that lies opposite.

An F-suit card is led through the squeeze, declarer having the ability to shift the next round's winner to either hand. The diagram shows the three possible F-suit matrices (or their equivalents) that makes this possible:

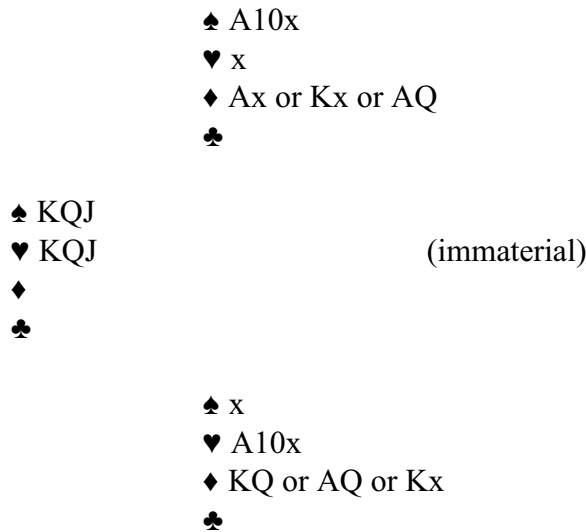

West must commit when South leads a diamond (K, A, and x, respectively, for the three matrices shown) that enables shifting of the next round's winner to the hand holding the suit that the squeeze abandons. South then plays the ace and another of that suit, having preserved a matrix entry to the established card.

If avoidance play is necessary to keep the squeeze's partner off lead, the matrix requirements may be more stringent. Give East Jx of hearts in the above diagram, plus some good clubs, and the second matrix (AQ of diamonds South, Kx North, diamond ace led) won't work because establishing hearts safely requires the heart lead to come from the North hand, South inserting the ten. West could safely discard a high heart (to unblock) on the heart ace if East has Jx of hearts and one or more club tricks.

Sometimes an odd finesse must be taken to achieve the proper matrix:

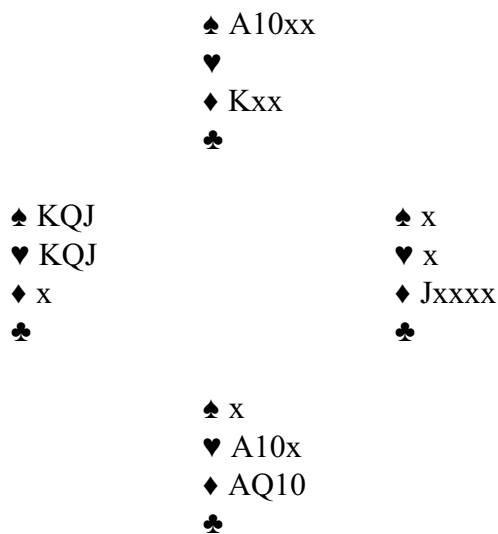

Declarer leads a small diamond from the North hand and finesses the ten! He then leads the diamond ace, following from the North hand with the card that preserves a diamond entry to the suit that West abandons.

The diamond finesse was necessary to achieve the matrix required for entry shifting, without which there would be no squeeze. Usually, however, it is only necessary to take care to cash F-suit winners in a way that provides a proper matrix.

B. One hand has a void in the protected CLA threat suit that lies opposite.

The CLA threat in the hand with the void must be extended to make up for the lack of communication. The matrix must be the equivalent of AQ over the squeeze with Kx opposite:

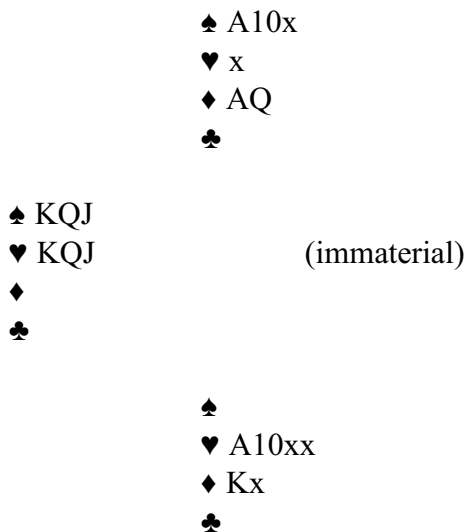

Declarer leads the small card from the Kx of diamonds toward North's AQ, winning with the card that preserves a diamond entry to the suit that West abandons. If West unguards hearts, the ace of diamonds wins the first trick and the extended heart threat makes up for the lack of communication to the spade ace, with the diamond king as entry. If West unguards spades, then the queen of diamonds wins the first trick and spades are established, with the diamond ace as entry.